

SUPLEMENTO  
**K26**



SUPLEMENTO  
**K26**



<b>TC</b>	<b>TERMOS E CONDIÇÕES</b> Página 3-4	<b>09</b>	<b>FERRAMENTA ELÉTRICA</b> Página 81-82
<b>SB</b>	<b>SIMBOLOGIA</b> Página 5-6	<b>10</b>	<b>FERRAMENTA PNEUMÁTICA</b> Não tem novos produtos
<b>01</b>	<b>FERRAMENTA MANUAL</b> Página 9-18	<b>11</b>	<b>FERRAMENTA HIDRÁULICA</b> Página 85-92
<b>02</b>	<b>ALICATES</b> Página 21-22	<b>12</b>	<b>FERRAMENTA LUBRIFICAÇÃO</b> Página 95-96
<b>03</b>	<b>BITS E CONJUNTOS</b> Página 25-28	<b>13</b>	<b>EQUIPAMENTO GARAGEM</b> Página 99-112
<b>04</b>	<b>FERRAMENTA ESPECÍFICA</b> Página 31-37	<b>RT</b>	<b>ROUPA DE TRABALHO</b> Página 115-116
<b>05</b>	<b>FERRAMENTA CARROÇARIA</b> Página 41-42	<b>MR</b>	<b>MERCHANDISING</b> Página 119-120
<b>06</b>	<b>REGULAÇÃO E TESTE</b> Página 45-48	<b>EP</b>	<b>EXPOSITORES</b> Não tem novos produtos
<b>07</b>	<b>FERRAMENTA MOTOR</b> Página 51-52	<b>LR</b>	<b>LOCALIZAÇÃO REFERÊNCIAS</b> Página 123-124
<b>08</b>	<b>KITS SINCRONIZAÇÃO</b> Página 55-78		

# ÍNDICE

<b>TC</b>	<b>TERMINOS Y CONDICIONES</b> Página 3-4	<b>09</b>	<b>HERRAMIENTA ELÉCTRICA</b> Página 81-82
<b>SB</b>	<b>SIMBOLOGÍA</b> Página 5-6	<b>10</b>	<b>HERRAMIENTA NEUMÁTICA</b> No tiene productos nuevos
<b>01</b>	<b>HERRAMIENTA MANUAL</b> Página 9-18	<b>11</b>	<b>HERRAMIENTA HIDRÁULICA</b> Página 85-92
<b>02</b>	<b>ALICATES</b> Página 21-22	<b>12</b>	<b>HERRAMIENTA LUBRICACIÓN</b> Página 95-96
<b>03</b>	<b>PUNTAS Y CONJUNTOS</b> Página 25-28	<b>13</b>	<b>EQUIPAMIENTO PARA TALLER</b> Página 99-112
<b>04</b>	<b>HERRAMIENTA ESPECÍFICA</b> Página 31-37	<b>RT</b>	<b>ROPA DE TRABAJO</b> Página 115-116
<b>05</b>	<b>HERRAMIENTA DE CARROCERIA</b> Página 41-42	<b>MR</b>	<b>MERCHANDISING</b> Página 119-120
<b>06</b>	<b>REGULACIÓN Y PRUEBAS</b> Página 45-48	<b>EP</b>	<b>EXPOSITORES</b> No tiene productos nuevos
<b>07</b>	<b>HERRAMIENTA PARA MOTOR</b> Página 51-52	<b>LR</b>	<b>LOCALIZACIÓN REFERENCIAS</b> Página 123-124
<b>08</b>	<b>KITS CALADO</b> Página 55-78		

#### I - Âmbito de Aplicação

- a) As condições estabelecem os princípios gerais de venda e serviços pelos quais se devem pautar as relações entre a Kroftools e os seus clientes.

#### II - Fornecimentos

- a) Para abertura de crédito, será necessária aprovação da Companhia de Seguros Coface e segundo critérios internos estabelecidos. A análise de concessão será feita após preenchimento de questionário em impresso próprio, pelo cliente.  
b) As faturas têm um prazo de 60 dias. No caso do crédito ser aprovado, a primeira encomenda será a pré-pagamento.  
c) A Kroftools reserva-se no direito de, em qualquer momento, cancelar os fornecimentos, nomeadamente nos casos em que os limites de crédito, em valor ou em prazo sejam ultrapassados.  
d) No caso de não apresentar os requisitos necessários para obtenção de crédito a mercadoria será enviada a pronto pagamento ou outra condição previamente acordada com a Kroftools.

#### III - Preços

- a) As encomendas aceitam-se nas condições bem expressas de que nos reservam o direito de alterar tanto o preço como os descontos estabelecidos enquanto não faturado (em virtude de alterações de preço de fabrico, câmbios, etc.) sem obrigatoriedade de aviso prévio.

#### IV - Expedição

- a) O transportador será escolhido pela Kroftools, salvo indicação contrária por parte do cliente.  
b) Os portes são por conta do cliente, salvo acordo entre a Kroftools e o cliente.  
c) A entrega considera-se feita no estabelecimento do cliente ou no local onde o cliente ou qualquer representante desta o receba.  
d) É responsabilidade do cliente no ato e receção do pedido, verificar o número de volumes e estado dos mesmos, devendo efetuar no momento a reclamação à transportadora de qualquer erro / defeito detetado. A Kroftools não se responsabilizará por qualquer reclamação posterior por danos e/ou perdas de material onde fique comprovado que as mesmas eram detetáveis no ato de receção.

#### V - Reclamações, devoluções

- a) As reclamações e/ou devoluções relativas a fornecimentos só são aceites no prazo máximo de quinze dias a contar da data de receção da mercadoria. Qualquer reclamação fora desse prazo, deverá ser formalizada com o respetivo justificativo para análise do Departamento Comercial.  
b) A mercadoria a devolver terá de ser sempre acompanhada por uma Nota de Devolução com menção de número(s) de documento(s) a que respeita o(s) artigo(s) devolvido (artigo 36º alínea b do código do Civa), ou cópia do documento de venda.  
c) Não serão aceites devoluções de artigos rececionados, com marcas de utilização ou danos na embalagem original

#### VI - Garantias

- a) Todos os produtos têm garantia prevista na lei.  
b) Para beneficiar da garantia, o cliente deverá informar a Kroftools no prazo máximo de 2 semanas a contar da data de deteção da falta de conformidade do produto.  
c) O material enviado para garantia deverá vir acompanhado por documento onde identifique data de compra e/ou data de venda ao consumidor final, assim como descritivo do problema detetado no equipamento.  
d) A Kroftools não se responsabiliza por situações em que o material não se encontre em conformidade com os desenhos ou especificações de fábrica.

#### VII - Pagamentos

Condições gerais de pagamento:

- a) A data do vencimento das faturas é de 60 dias, no caso de existir aprovação de crédito por parte da seguradora.  
b) A Kroftools reserva-se no direito de debitar juros de mora à taxa legal nos atrasos de pagamento de documentos vencidos e não pagos.  
c) A Kroftools reserva-se no direito de alterar as condições gerais em qualquer altura.

#### VIII - Dados Bancários

BPI IBAN: PT50 0010 0000 16151620001 86  
SWIFT/BIC: BBPIPTPL  
CGD IBAN: PT50 0035 0776 00000462130 60  
SWIFT/BIC: CGDIPTPL  
BANKINTER IBAN: PT50 0269 0663 00209377509 04  
SWIFT/BIC: BKBKPTPL  
SANTANDER TOTTA IBAN: PT50 0018 0003 32301673020 43  
SWIFT/BIC: TOTAPTPL  
MILLENNIUM BCP IBAN: PT50 0033 0000 45450804128 05  
SWIFT/BIC: BCOMPTPL  
CRÉDITO AGRÍCOLA IBAN: PT50 0045 1450 40314809010 93  
SWIFT/BIC: CCCMPTPL  
MONTEPIO IBAN: PT50 0036 0038 99100768233 62  
BIC/SWIFT: MPIOPTPL  
CAIXABANK IBAN: ES59 2100 6433 79020003 5448  
SWIFT/BIC: CAIXESBXXX

#### IX - Compartilhamento de Dados (RGPD)

- a) A kroftools responsabiliza-se pelo uso dos dados dos nossos clientes única e exclusivamente para efeitos comerciais.  
b) Serão compartilhados com terceiros apenas os dados necessários à expedição das mercadorias.  
c) É responsabilidade do distribuidor Kroftools assegurar a boa prática da RGPD no fornecimento de dados de terceiros (consumidor final).

#### X - Outros

- a) Para julgar toda ou qualquer ação judicial, o Tribunal da Comarca de Braga é o único competente.

**I - Ámbito de Aplicación**

- a) Los términos y condiciones establecen los principios generales de venta y servicio que deben guiar la relación entre Kroftools y sus clientes.

**II - Suministros**

- a) Para abrir un préstamo, será necesaria la aprobación de la Compañía de Segros Coface, de acuerdo con los criterios internos establecidos. El proceso de aprobación se analizará después de que el cliente haya cumplimentado un cuestionario en un formulario aparte.  
b) Las facturas vencen a los 60 días. Si se aprueba el crédito, el primer pedido se pagará por adelantado.  
c) Kroftools se reserva el derecho de cancelar las entregas en cualquier momento, especialmente en los casos en que se superen los límites de crédito, en términos de valor o de tiempo.  
d) Si no cumple los requisitos para obtener crédito, la mercancía le será enviada al contado o bajo otra condición previamente acordada con Kroftools.

**III - Precios**

- a) Los pedidos se aceptan con la condición expresa de que nos reservamos el derecho a modificar sin previo aviso tanto el precio como los descuentos establecidos mientras no se facturen (debido a variaciones en los precios de fabricación, tipos de cambio, etc.).

**IV - Envío**

- a) El transporte será elegido por Kroftools, salvo que el cliente indique lo contrario.  
b) Los gastos de envío correrán a cargo del cliente, salvo acuerdo entre Kroftools y el cliente.  
c) La entrega se considerará efectuada en los locales del cliente o en el lugar donde el cliente o cualquier representante del mismo la reciba.  
d) Es responsabilidad del cliente al recibir el pedido comprobar el número de bultos y su estado, así como reclamar con el transporte cualquier error / defecto detectado en el momento. Kroftools no se hará responsable de reclamaciones posteriores por daños y/o pérdidas de material cuando se demuestre que eran detectables en el momento de la recepción.

**V - Reclamaciones, Devoluciones**

- a) Sólo se aceptarán reclamaciones y/o devoluciones relativas a entregas en un plazo máximo de ocho días desde la fecha de recepción de la mercancía. Cualquier reclamación fuera de este plazo deberá formalizarse con la correspondiente justificación para su análisis por el departamento de Ventas.  
b) La mercancía a devolver debe ir siempre acompañada de una Nota de Devolución en la que se mencione el número o números de documento a los que se refiere el artículo o artículos devueltos (artículo 36(b) del código Civa), o de una copia del artículo de venta.  
c) No se aceptarán devoluciones de artículos recibidos con marcas de uso o daños en el embalaje original.

**VI - Garantías**

- a) Todos los productos están garantizados por ley.  
b) Para beneficiarse de la garantía, el cliente deberá informar a Kroftools en un plazo máximo de 2 semanas a partir de la fecha de detección de la falta de conformidad del producto.  
c) El material enviado en garantía debe ir acompañado de un documento que identifique la fecha de compra y/o la fecha de venta al consumidor final, así como una descripción del problema detectado en el equipo.  
d) Kroftools no se hace responsable de situaciones en las que el material no se ajuste a los planos o especificaciones de fábrica.

**VII - Pago****Condiciones generales de pago**

- a) La fecha de vencimiento de las facturas es de 60 días, en caso de aprobación del crédito por parte de la aseguradora.  
b) Kroftools Lda se reserva el derecho de cobrar intereses al tipo legal por demora en el pago de documentos vencidos e impagados.  
c) Kroftools se reserva el derecho de modificar las condiciones generales en cualquier momento.

**VIII - Datos Bancarios**

























































BPI IBAN: PT50 0010 0000 16151620001 86  
SWIFT/BIC: BBPIPTPL  
CGD IBAN: PT50 0035 0776 00000462130 60  
SWIFT/BIC: CGDIPTPL  
BANKINTER IBAN: PT50 0269 0663 00209377509 04  
SWIFT/BIC: BKBKPTPL  
SANTANDER TOTTA IBAN: PT50 0018 0003 32301673020 43  
SWIFT/BIC: TOTAPTPL  
MILLENNIUM BCP IBAN: PT50 0033 0000 45450804128 05  
SWIFT/BIC: BCOMPTPL  
CRÉDITO AGRÍCOLA IBAN: PT50 0045 1450 40314809010 93  
SWIFT/BIC: CCCMPTPL  
MONTEPIO IBAN: PT50 0036 0038 99100768233 62  
BIC/SWIFT: MPLOPTPL  
CAIXABANK IBAN: ES59 2100 6433 79020003 5448  
SWIFT/BIC: CAIXESBBXXX

**IX - Intercambio de datos (GDPR)**

- a) Kroftools es responsable del uso de los datos de nuestros clientes única y exclusivamente con fines comerciales.  
b) Sólo se compartirán con terceros los datos necesarios para el envío de las mercancías.  
c) Es responsabilidad del distribuidor de kroftools garantizar las buenas prácticas del GDPR en el suministro de datos de terceros (consumidor final).

**X - Otros**

- a) El Tribunal de Braga es el único competente para conocer de cualquier acción judicial.

 Quantidade por caixa	 Peso líquido artigo	 Altura	 Comprimento	 Hexagonal
 Bi-hexagonal	 Torx	 Bit hexagonal	 Fenda	 Bit Torx
 Bit Phillips	 Bit Pozidriv	 Bit Torx Furado	 Ribe Furado	 Bit Ribe
 Bit Torx TS	 Bit XZN	 Bit XZN furado	 Bit Quadrado	 Bit hex furado
 Martelo mecânico	 Martelo Bola	 Abraçadeira	 Quadra	 Abertura
 Diâmetro	 Medidas Gerais	 Magnetismo	 Capacidade Líquido	 Capacidade Peso
 Rotação	 Quantidade	 Pressão manómetro	 Temperatura	 Amperagem Voltagem
 Bidón	 Cilindrada motor	 Iluminação	 Carregamento	 Comprimento Cabo
 Diâmetro	 Desaperto	 Aperto	 Abertura	 Peso suportado
 Informação	 Escala	 Voltagem Motor	 Bit Clutch	 Bit Torq
 Código motor	 Bit Triwing	 Bit Spanner	 Bit Torx Plus	 Modelo
		 Bit Robertson		



Cantidad por caja



Peso neto



Altura



Longitud



Hexagonal



Bihexagonal



Torx



Punta hexagonal



Plano



Punta torx



Punta Phillips



Punta Pozidriv



Punta Torx Inviolable



Ribe inviolable



Punta Ribbe



Punta Torx TS



Punta XZN



Punta XZN inviolable



Punta Cuadrada



Punta Hex inviolable



Martillo mecánico



Martillo Bola



Abrazadera



Cuadrado



Apertura



Diámetro



Medidas Generales



Magnetismo



Capacidad Líquido



Capacidad Peso



Rotación



Cantidad



Presión manómetro



Temperatura



Amperaje Tensión



Bidón



Cilindrada motor



Iluminación



Cargamento



Longitud Cable



Diámetro



Aloje



Apriete



Apertura



Peso soportado



Información



Escala



Voltaje motor



Punta Clutch



Punta Torq



Código motor



Punta Triwing



Punta Spanner



Punta Torx Plus



Modelo



Punta Cuadrada

FERRAMENTA MANUAL

HERRAMIENTA MANUAL

01

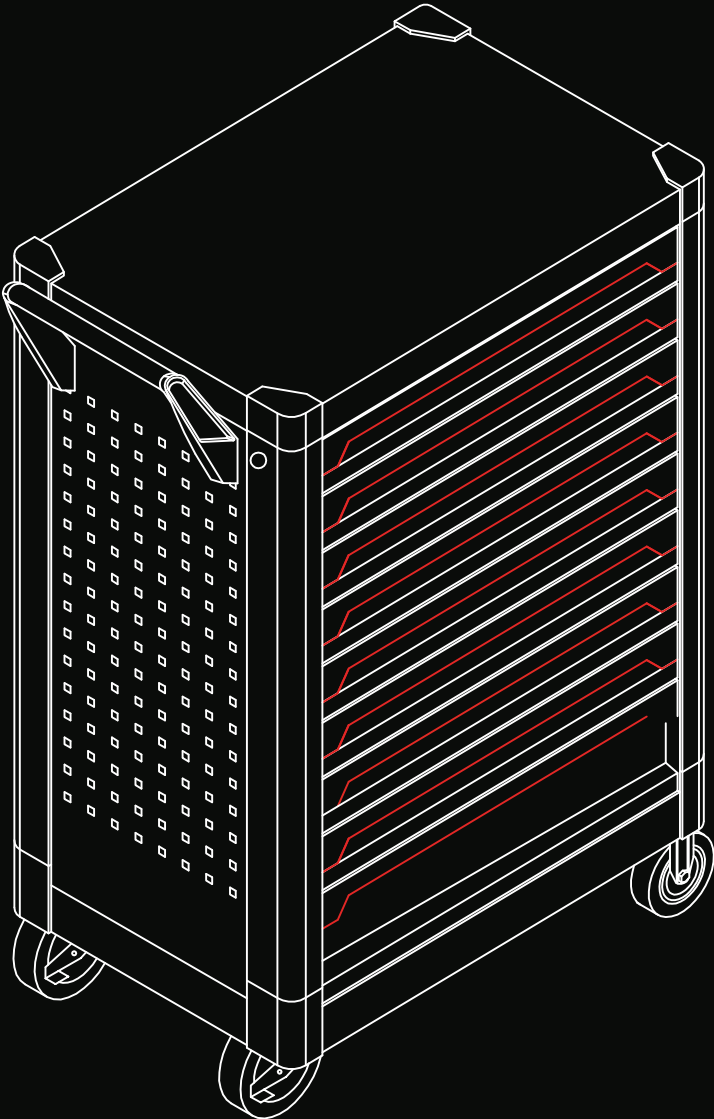

 <b>FAMÍLIA</b>	<b>PÁGINAS</b>
<b>01 FERRAMENTA MANUAL</b>	<b>9-18</b>
02 ALICATES	21-22
03 BITS E CONJUNTOS	25-28
04 FERRAMENTA ESPECÍFICA	31-37
05 FERRAMENTA CARROÇARIA	41-42
06 REGULAÇÃO E TESTE	45-48
07 FERRAMENTA MOTOR	51-52
08 KITS SINCRONIZAÇÃO	55-78
09 FERRAMENTA ELÉTRICA	81-82
10 FERRAMENTA PNEUMÁTICA	---
11 FERRAMENTA HIDRÁULICA	85-92
12 FERRAMENTA LUBRIFICAÇÃO	95-96
13 EQUIPAMENTO GARAGEM	99-112
RT ROUPA DE TRABALHO	115-116
MR MERCHANDISING	119-120
EP EXPOSITORES	---
LR LOCALIZAÇÃO REFERÊNCIAS	123-124

 <b>FAMILIA</b>	<b>PÁGINAS</b>
<b>01 HERRAMIENTA MANUAL</b>	<b>9-18</b>
02 ALICATES	21-22
03 PUNTAS Y CONJUNTOS	25-28
04 HERRAMIENTA ESPECÍFICA	31-37
05 HERRAMIENTA DE CARROCERIA	41-42
06 REGULACIÓN Y PRUEBAS	45-48
07 HERRAMIENTA PARA MOTOR	51-52
08 KITS CALADO	55-78
09 HERRAMIENTA ELÉCTRICA	81-82
10 HERRAMIENTA NEUMÁTICA	---
11 HERRAMIENTA HIDRÁULICA	85-92
12 HERRAMIENTA LUBRICACIÓN	95-96
13 EQUIPAMENTO PARA TALLER	99-112
RT ROPA DE TRABAJO	115-116
MR MERCHANDISING	119-120
EP EXPOSITORES	---
LR LOCALIZACIÓN REFERENCIAS	123-124

-  Carro ferramentas PROLINE 9 gavetas vazio
-  Carro de herramientas PROLINE de 9 cajones vacío

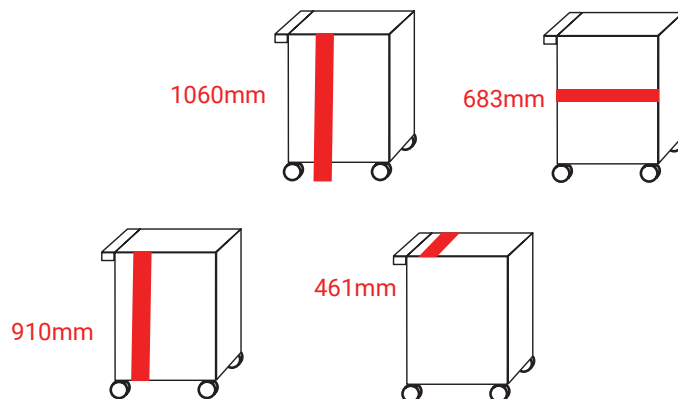

**Dimensões gerais:**  
 Altura total: 1060mm  
 Altura do carro (sem rodas): 910mm  
 Largura: 683mm  
 Profundidade: 461mm  
 Largura pega: 310mm  
 Profundidade pega: 80mm

**Material:** Aço + PP

**8 x Gavetas pequenas (superiores):**  
 Dimensões internas (L x P x A): 545x400x60mm  
 Altura frontal da gaveta: 75mm  
 Largura externa: 575mm

**1 x Gaveta grande (inferior):**  
 Dimensões internas (L x P x A): 545x400x140mm  
 Altura frontal da gaveta: 154mm  
 Largura externa: 575mm

**Dimensiones generales:**  
 Altura total: 1060mm  
 Altura del carro (sin ruedas): 910mm  
 Ancho: 683mm  
 Profundidad: 461mm  
 Ancho del asa: 310mm  
 Profundidad del asa: 80mm

**Material:** Acero + PP

**8 x Cajones pequeños (superiores):**  
 Dimensiones internas (An x P x Al): 545x400x60mm  
 Altura frontal del cajón: 75mm  
 Ancho exterior: 575mm

**1 x Cajón grande (inferior):**  
 Dimensiones internas (An x P x Al): 545x400x140mm  
 Altura frontal del cajón: 154mm  
 Ancho exterior: 575mm

REF



8636



64,5kg



1x

 Carro ferramentas proline 9 gavetas 318pcs  
 Carro de herramientas proline de 9 cajones 318pzs

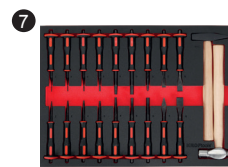
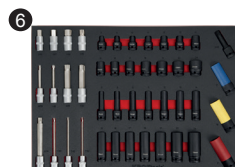
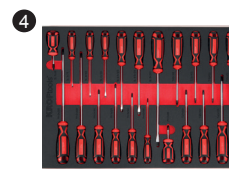
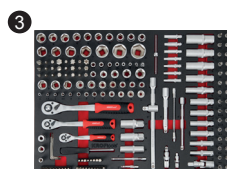
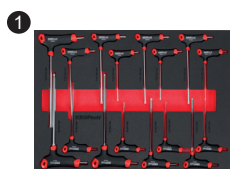
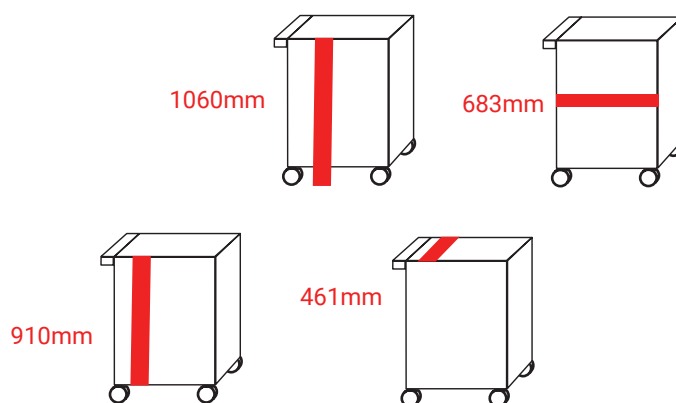

Módulos	Quantidade	Descrição
1	16x	Módulo de chaves Allen em T
2	24x	Módulo de chaves fixas
3	180x	Módulo de chaves de caixa
4	21x	Módulo de chaves de fendas/cruz
5	12x	Módulo de alicates
6	44x	Módulo de bits de impacto
7	20x	Módulo de cinzeis

Módulos	Cantidad	Descripción
1	16x	Módulo de llaves Allen en T
2	24x	Módulo de llaves fijas
3	180x	Módulo de llaves de vaso
4	21x	Módulo de destornilladores
5	12x	Módulo de alicates
6	44x	Módulo de vasos de impacto
7	20x	Módulo de cinceles

 **Dimensões gerais:**  
 Altura total: 1060mm  
 Altura do carro (sem rodas): 910mm  
 Largura: 683mm  
 Profundidade: 461mm  
 Largura pega: 310mm  
 Profundidade pega: 80mm

**Material:** Aço + PP

**8 x Gavetas pequenas (superiores):**  
 Dimensões internas (L x P x A): 545x400x60mm  
 Altura frontal da gaveta: 75mm  
 Largura externa: 575mm

**1 x Gaveta grande (inferior):**  
 Dimensões internas (L x P x A): 545x400x140mm  
 Altura frontal da gaveta: 154mm  
 Largura externa: 575mm

 **Dimensiones generales:**  
 Altura total: 1060mm  
 Altura del carro (sin ruedas): 910mm  
 Ancho: 683mm  
 Profundidad: 461mm  
 Ancho del asa: 310mm  
 Profundidad del asa: 80mm

**Material:** Acero + PP

**8 x Cajones pequeños (superiores):**  
 Dimensiones internas (An x P x Al): 545x400 x60mm  
 Altura frontal del cajón: 75mm  
 Ancho exterior: 575mm

**1 x Cajón grande (inferior):**  
 Dimensiones internas (An x P x Al): 545 400x140mm  
 Altura frontal del cajón: 154mm  
 Ancho exterior: 575mm

REF  
8637

  
72,5kg

  
1x

Conjunto ferramentas 318pcs  
Juego de herramientas 318pcs

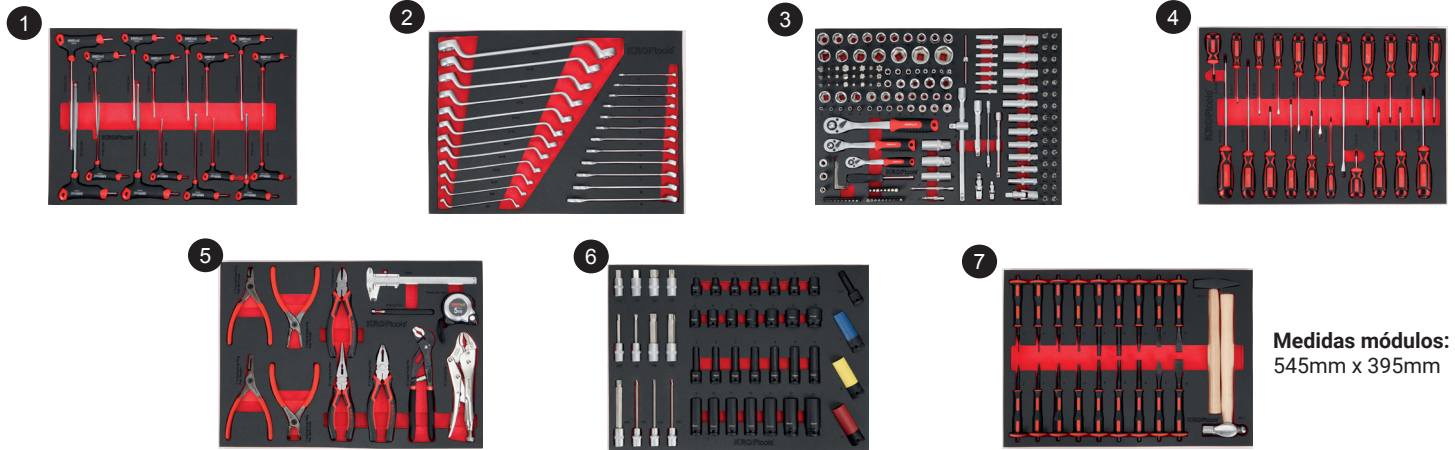

Medidas módulos:  
545mm x 395mm



- 1 (8x) Chaves T umbrako/ Llaves T umbrako: 2\*100, 2.5\*100, 3\*100, 4\*150, 5\*150, 6\*150, 8\*200, 10\*200mm (CRV)  
(8x) Chaves T torx/ Llaves T torx: T10\*100, T15\*100, T20\*100, T25\*150, T27\*150, T30\*150, T40\*150, T45\*200mm (CRV)
- 2 (12x) Chaves de luneta/ Llaves estrella: 6,7,8,9,10,11,12,13,14,15,16,17,18,19,21,22mm (CRV)  
(12x) Chaves de boca luneta/ Llaves combinadas: 6\*7,8\*9,10\*11,12\*13,14\*15,16\*17,18\*19,20\*22mm (CRV)  
(3x) Roquetes/ Carracas: 3, 4, 5, 6, 8, 10, 12mm (40CR+CRMO)  
(5x) Aumentos/ Alargaderas: 1/4" (2" & 4"), 3/8"(6"), 1/2"(5"-10") (CRV)  
(3x) Cardans: 1/4", 3/8", 1/2" (CRV)  
(1x) Barra deslizante: 1/4" (CRV)  
(1x) Tubo flexível/ Tubo flexible: 1/4" (CRV)  
(1x) Suporte de bits/Porta bits: 1/4" (CRV)  
(40x) Chaves de caixa métrica/ Llave de vaso métrica: 1/4": 4, 4.5, 5, 5.5, 6, 7, 8, 9, 10, 11, 12, 13, 14mm; 3/8": 10, 11, 12, 13, 14, 15, 16, 17, 18, 19; 1/2": 10, 11, 12, 13, 14, 15, 16, 17, 18, 19, 20, 21, 22, 24, 27, 30, 32mm (CRV)
- 3 (13x) Chaves de caixa E/ Llave de vaso E: 1/4": E4, E5, E6, E7, E8; 3/8": E10, E11, E12, E14, E16, E18; 1/2": E20, E24 (CRV)  
(12x) Chaves de caixa longa métrica/ Llave de vaso longa métrica: 1/4": 4, 5, 6, 7, 8, 9, 10mm; 1/2": 16, 17, 18, 19, 22mm (CRV)  
(6x) Chaves de caixa longa/ Llave de vaso longa: 10, 11, 12, 13, 14, 15mm (CRV)  
(2x) Adaptadores: 1/4", 1/2" (CRV)  
(30x) Bits: T30, T27, T25, T20, T15, T10, T9, T8, TT8, TT9, TT10, TT15, TT20, TT25, TT27, TT30, H3, H4, H5, H6, SL4, SL5.5, SL6.5, SL7, PH1, PH2, PH3, PZ1, PZ2, PZ3  
(24x) Bits 30mm: SL8, 10, 12, PH3, PH4, PZ3, PZ4, H7, 8, 10, 12, 14, T40, T45, T50, T55, T60, T70, TT40, TT45, TT50, TT55, TT60, TT70  
(28x) Bits 25mm: T5, T63, T7, T8, T9, T10, T15, T20, T25, T27, T30, TT7, TS10, TS15, TS20, TS25, TS27, TS30, TS40, TS45, M5, M6, M8(XZN), M5, M6, M7, M8, M9(RIBE)  
(1x) Conector em T: 1/2" DR.  
(7x) Chave Allen/ Llave Allen: 1.27, 1.5, 2, 2.5, 3, 4, 5mm
- 4 (7x) Chaves de fendas/ Destornilladores planos: 3\*75, 3\*100, 6\*38, 4\*100, 5.5\*125, 6.5\*125, 8\*200mm (CRV)  
(7x) Chaves Phillips/ Destornilladores Phillips: PH0\*100, PH1\*100, PH1\*125, PH2\*38, PH2\*100, PH2\*200, PH3\*200mm (CRV)  
(7x) Chaves Torx/ Destornilladores Torx: T10\*100, T15\*100, T20\*100, T25\*100, T27\*100, T30\*100, T40\*125mm (CRV)  
(1x) Alicates de bloqueio 10"/ Alicates de presión 10" (CRV)  
(1x) Alicates bomba de água 10"/ Alicates bomba de agua 10" (CRV)  
(1x) Alicates universal 8"/ Alicates universal 8" (CRV)  
(1x) Alicates de ponta longa 8"/ Alicates de punta larga 8" (CRV)
- 5 (1x) Alicates diagonal 7"/ Alicates de corte diagonal 7" (CRV)  
(4x) Alicates para anéis internos com bico curvo e externos com bico curvo, Alicates para anéis internos retos e externos retos 7"/ Alicates para anillos interiores con punta curva y exteriores con punta curva, Alicates para anillos interiores rectos y exteriores rectos 7" (CRV)  
(1x) Fita métrica 5M/ Cinta métrica 5M (aço carbono/ acero al carbono+ABS+TPR)  
(1x) Paquímetro 0-150mm/ Calibre 0-150mm (aço carbono/ acero al carbono)  
(1x) Ferramenta de recolha magnética - Comprimento estendido: 640mm/ Herramienta de recogida - Longitud extendida: 640mm (aço carbono/ acero al carbono)
- 6 (4x) Bits 1/2, comprimento 55mm / Pontas de vaso 1/2", longitud 55mm H14, H17, H19, M16 (CRV, S2 bits)  
(4x) Bits 1/2, comprimento 99mm / Pontas de vaso 1/2", longitud 99mm MP9, M9, M16, T80 (CRV, S2 bits)  
(4x) Bits 1/2, comprimento 139mm / Pontas de vaso 1/2", longitud 139mm T40, T45, T50, M14 (CRV, S2 bits)
- 7 (1x) Bit 1/2"DR. M18\*78mm de comprimento / Punta 1/2"DR. M18\*78mm de longitud (CR-MO)  
(14x) Chaves/Vasos de impacto 1/2"DR. 8, 9, 10, 11, 12, 13, 14, 15, 16, 17, 19, 21, 22, 24mm (CR-MO)  
(14x) Chaves/Vasos de impacto 1/2"DR. 8, 9, 10, 11, 12, 13, 14, 15, 16, 17, 19, 21, 22, 24mm (CR-MO)  
(3x) Protetor de velas de ignição de impacto 17, 19, 21mm (CR-MO)  
(1x) Martelo de mecânica 300g / Martillo de mecánico 300g (Aço carbono com cabo de madeira/ Acero al carbono con mango de madera)
- 7 (1x) Martelo de bola (ball pein) 16oz / Martillo de bola 16oz (Aço carbono com cabo de madeira/ Acero al carbono con mango de madera)  
(18x) Cinzéis/ Cinceles: Cilíndricos: 2\*170, 3\*170, 4\*170, 5\*170, 8\*180, 10\*180mm; Cónicos: 2\*170, 3\*170, 4\*170, 5\*170, 6\*180, 8\*180, 10\*180mm; Triangular: 6\*180; Planos: 12\*160, 16\*175, 19\*180mm; Ponteiro/ Punzón central: 6\*170mm (CRV)

REF

8638



28,2kg



1x

**Carro ferramenta 7 gavetas 160 pcs**  
**Carro herramientas 7 cajones 160 piezas**

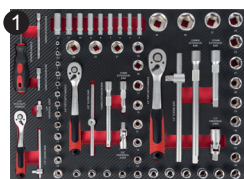
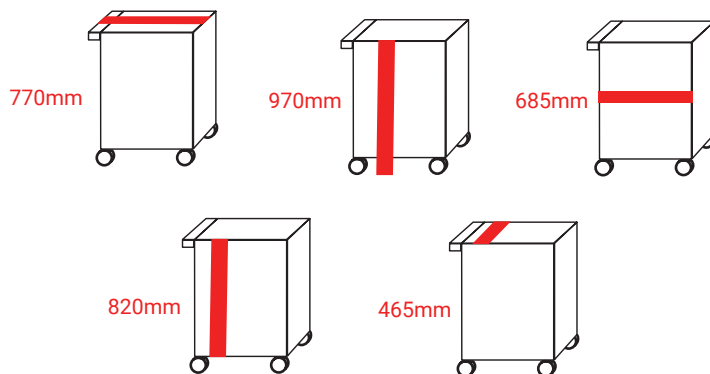

Módulos	Descrição
1	(3x) Cabo de roquete: 1/4"-3/8"-1/2" (1x) Barra deslizante 1/4": 115mm (3x) Junta universal: 1/4"-3/8"-1/2" (2x) Barra de extensão 1/4": 50-100mm (1x) Cabo giratório: 1/4" (13x) Chave de caixa hexagonal 1/4": 4-4.5-5-5.5-6-7-8-9-10-11-12-13-14mm (9x) Chave de caixa hexagonal funda 1/4": 4-5-6-7-8-9-10-11-12mm (1x) Barra deslizante 3/8": 165mm (2x) Barra de extensão: 75-150mm (15x) Chave de caixa hexagonal 3/8": 8-9-10-11-12-13-14-15-16-17-18-19-21-22-24mm (1x) Barra deslizante 1/2": 250mm (2x) Barra de extensão: 125-250mm (17x) Chave de caixa hexagonal 1/2": 10-11-12-13-14-15-16-17-18-19-20-21-22-24-27-30-32mm
2	(17x) Chave combinada: 6-7-8-9-10-11-12-13-14-15-16-17-18-19-20-21-22mm (8x) Chave de anel dupla: 6x7; 8x9; 10x11; 12x13; 14x15; 16x17; 18x19; 20x22mm (10x) Chave de boca: 6x7; 8x9; 10x11; 12x13; 14x15; 16x17; 18x19; 20x22; 24x27; 30x32mm
3	(6x) Chave de fendas SL: SL638-SL375-SL4100-SL5100-SL6150-SL8200mm (6x) Chave Phillips PH: PH238-PH075-PH1100-PH2100-PH2150-PH3150mm (6x) Chave de fendas isolada: SL375-SL4100-SL5.5125-PH075-PH1100-PH2100mm (6x) Chave de precisão eletrônica: SL240-SL2.440-SL340-PH140-PH0040-PH040mm (8x) Chave dobrável Torx: T9-T10-T15-T20-T25-T27-T30-T40
4	(4x) Alicate de anéis elásticos 6" (1x) Alicate de corte diagonal 7.5" (1x) Alicate combinado 8" (1x) Alicate de pontas longas 8" (1x) Alicate bomba de água 10" (1x) Alicate de pressão 10"
5	(6x) Chave em T Torx: T10100-T15100-T20100-T25150-T27150-T30150mm (6x) Chave em T Hexagonal: H2100-H2.5100-H3100-H4150-H5150-H6150mm (1x) Martelo de mecânico 300g (1x) Malhete 40mm

Módulos	Descripción
1	(3x) Mango de carraca: 1/4"-3/8"-1/2" (1x) Barra deslizante 1/4": 115 mm (3x) Junta universal: 1/4"-3/8"-1/2" (2x) Barra de extensión 1/4": 50-100 mm (1x) Mango giratorio: 1/4" (13x) Vaso hexagonal 1/4": 4-4.5-5-5.5-6-7-8-9-10-11-12-13-14mm (9x) Vaso hexagonal profundo 1/4": 4-5-6-7-8-9-10-11-12mm (1x) Barra deslizante 3/8": 165mm (2x) Barra de extensión 3/8": 75-150mm (15x) Vaso hexagonal 3/8": 8-9-10-11-12-13-14-15-16-17-18-19-21-22-24mm (1x) Barra deslizante 1/2": 250mm (2x) Barra de extensión 1/2": 125-250mm (17x) Vaso hexagonal 1/2": 10-11-12-13-14-15-16-17-18-19-20-21-22-24-27-30-32mm
2	(17x) Llave combinada: 6-7-8-9-10-11-12-13-14-15-16-17-18-19-20-21-22 mm (8x) Llave de estrella doble: 6x7; 8x9; 10x11; 12x13; 14x15; 16x17; 18x19; 20x22 mm (10x) Llave fija: 6x7; 8x9; 10x11; 12x13; 14x15; 16x17; 18x19; 20x22; 24x27; 30x32mm
3	(6x) Destornillador plano SL: SL638-SL375-SL4100-SL5100-SL6150-SL8200 mm (6x) Destornillador Phillips PH: PH238-PH075-PH1100-PH2100-PH2150-PH3150 mm (6x) Destornillador aislado: SL375-SL4100-SL5.5125-PH075-PH1100-PH2100 mm (6x) Destornillador de precisión electrónica: SL240-SL2.440-SL340-PH140-PH0040-PH040mm (8x) Llave plegable Torx: T9-T10-T15-T20-T25-T27-T30-T40
4	(4x) Alicate para anillos elásticos 6" (1x) Alicate de corte diagonal 7.5" (1x) Alicate combinado 8" (1x) Alicate de punta larga 8" (1x) Alicate bomba de agua 10" (1x) Alicate de presión 10"
5	(6x) Llave en T Torx: T10100-T15100-T20100-T25150-T27150-T30150 mm (6x) Llave en T hexagonal: H2100-H2.5100-H3100-H4150-H5150-H6150mm (1x) Martillo de mecánico 300g (1x) Mazo 40mm

**Gavetas:**

5 gavetas pequenas: 544x399x58mm; Carga máxima: 15kg  
 1 gaveta média: 544x399x128mm; Carga máxima: 20kg  
 1 gaveta grande: 544x399x195mm; Carga máxima: 20kg



**Cajones:**

5 cajones pequenos: 544x399x58mm; Carga máxima: 15kg  
 1 cajón mediano: 544x399x128mm; Carga máxima: 20kg  
 1 cajón grande: 544x399x195mm; Carga máxima: 20kg

REF

Cor / Color

8621  
8622Preto / Negro  
Vermelho / Rojo67kg  
67kg1x  
1x

 Módulo fixo 2 portas para canto sem fixações para suporte

 Módulo de esquina 2 puertas



 **Características:**

Espessura: 0,7-0,8mm

Pés ajustáveis: 40mm

Medidas: 924mm (Comprimento) x 457mm (Largura) x (Altura) 864mm

 **Características:**

Espesor: 0,7-0,8mm

Pies ajustables: 40mm

Medidas: 924mm (Largo) x 457mm (Ancho) x 864mm (Alto)

REF



8835

42,3kg

1x

 Módulo fixo parede para canto sem fixações para suporte

 Módulo esquina superior



 **Características:**

Espessura: 0,7-0,8mm

Medidas: 924mm (Comprimento) x 305mm (Largura) x 406mm (Altura)

 **Características:**

Espesor: 0,7-0,8mm

Medidas: 924mm (Largo) x 305mm (Ancho) x 406mm (Alto)

REF



8836

22,4kg

1x

 Painel perfurado para canto sem fixações para suporte

 Panel perforado para esquina

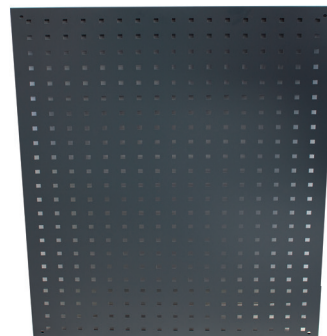

 **Características:**

Espessura: 1,0mm

Tamanho malha: 10x10mm

Medidas: 924mm (Comprimento) x 20mm (Largura) x 684mm (Altura)

 **Características:**

Espesor: 1,0mm

Tamaño malla: 10x10mm

Medidas: 924mm (Largo) x 20mm (Ancho) x 684mm (Alto)

REF



8837

5kg

1x

 Suporte para fixar 2 módulos de parede

 Soporte para fijar 2 módulos de pared

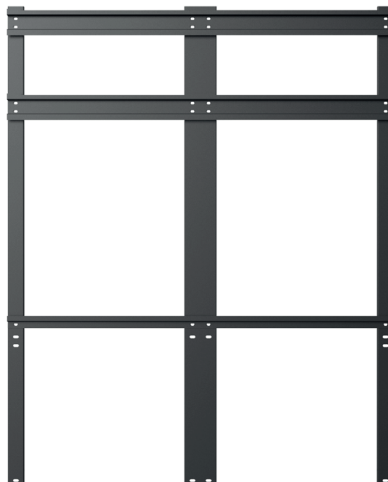

 **Características:**  
 Dimensões: 25mm (Comprimento) x 1318mm (Largura) x 1864mm (Altura)  
 Espessura: 1,5mm  
 Material: Aço SPCC  
 Capacidade máxima de carga: 100kg  
**Nota:** Compatível com Ref.: 8831

 **Características:**  
 Dimensiones: 25mm (Largo) x 1318mm (Ancho) x 1864mm (Alto)  
 Espesor: 1,5mm  
 Material: Acero SPCC  
 Capacidad máxima de carga: 100kg  
**Nota:** Compatible con Ref.: 8831

REF



8838

15,4kg

1x

 Suporte para fixar 3 módulos de parede

 Soporte para fijar 3 módulos de pared

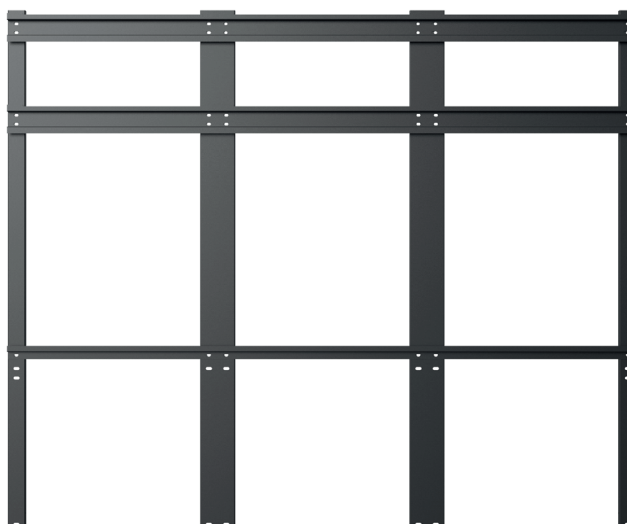

 **Características:**  
 Dimensões: 25mm (Comprimento) x 1978mm (Largura) x 1864mm (Altura)  
 Espessura: 1,5mm  
 Material: Aço SPCC  
 Capacidade máxima de carga: 150kg  
**Nota:** Compatível com Ref.: 8831

 **Características:**  
 Dimensiones: 25mm (Largo) x 1978mm (Ancho) x 1864mm (Alto)  
 Espesor: 1,5mm  
 Material: Acero SPCC  
 Capacidad máxima de carga: 150kg  
**Nota:** Compatible con Ref.: 8831



REF



8839

15,4kg

1x

-  **Bandeja móvel para serviços automóveis**
-  **Bandeja móvil para servicios automotrices**



 **NOTA:** Foto figurativa  
**NOTA:** Foto ilustrativa

 **Características:**  
Capacidade: 45kg  
Tamanho da base: 787x630mm  
Tamanho da bandeja (C x L x A): 737x508x28mm  
Altura mínima: 876mm  
Altura máxima: 1210mm  
Tubo de apoio: 46mm x 1,8mm  
Distância da base ao solo: 51mm  
Tamanho das rodas: 76mm

 **Características:**  
Capacidad: 45kg  
Tamaño de la base: 787x630mm  
Tamaño de la bandeja (L x A x H): 737x508x28mm  
Altura mínima: 876mm  
Altura máxima: 1210mm  
Tubo de soporte: 46mm x 1,8mm  
Distancia de la base al suelo: 51mm  
Tamaño de las ruedas: 76mm

**REF**

**8695**





**17kg**

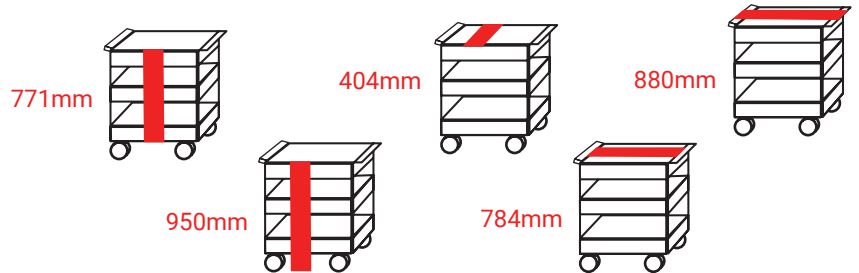

**1x**

-  **Carrinho com 3 prateleiras PROLINE**
-  **Carro con 3 estantes PROLINE**



 **Características:**  
Dimensões do produto (sem pega e rodas): 784x404x771mm  
Dimensões do produto (com pega e rodas): 880x404x950mm  
Dimensões da bandeja superior: 775x395x40mm  
Dimensões da bandeja intermédia e inferior: 775x395x80mm  
Espessura das bandejas: 0,8mm  
Espessura dos pilares: 2,0mm  
Dimensões das rodas: 5" 2 com travão. 2 fixas  
Carga máxima por bandeja: 100kg  
Carga máxima total do carrinho: 300kg

 **Características:**  
Dimensiones del producto (sin asa ni ruedas): 784x404x771mm  
Dimensiones del producto (con asa y ruedas): 880x404x950mm  
Dimensiones de la bandeja superior: 775x395x40mm  
Dimensiones de la bandeja intermedia e inferior: 775x395x80mm  
Espesor de las bandejas: 0,8mm  
Espesor de los pilares: 2,0mm  
Tamaño de las ruedas: 5" 2 con freno. 2 fijas  
Carga máxima por bandeja: 100kg  
Carga máxima total del carro: 300kg

**REF**



**8696**



**18,4kg**



**1x**

-  Tapete borracha estriado para bancada 8480  
 Alfombra de goma con forma de bandas



-  **Características:**  
 Espessura: 3mm  
 Medidas: 1997x697x3mm  
**NOTA:** Compatível com Bancada de trabalho 2MT C/ 2 Gavetas,  
 Ref: 8480

-  **Características:**  
 Espesor: 3mm  
 Medidas: 1997x697x3mm  
**NOTA:** Compatible con Banco de trabajo 2MT con 2 cajones,  
 Ref: 8480



REF





8480TE

5,7kg

1x

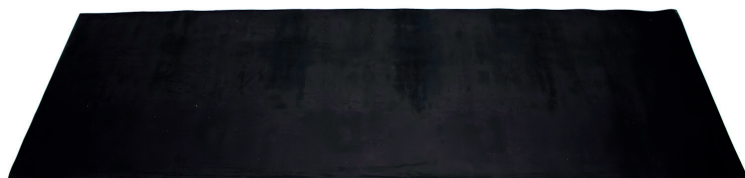
-  Tapete borracha liso para bancada 8480  
 Alfombra de goma forma plana



-  **Características:**  
 Espessura: 3mm  
 Medidas: 1997x697x3mm  
**NOTA:** Compatível com Bancada de trabalho 2MT C/ 2 Gavetas,  
 Ref: 8480

-  **Características:**  
 Espesor: 3mm  
 Medidas: 1997x697x3mm  
**NOTA:** Compatible con Banco de trabajo 2MT con 2 cajones,  
 Ref: 8480

REF



8480TL





5,76kg

1x

-  Chave phillips   
 Destornilladores phillips

-  Chave fenda   
 Destornilladores planos



REF				
235200	PH1	100mm	50gr	240x
2352038	PH2	38mm	50gr	360x
235206	PH2	150mm	119gr	180x

REF				
235100	6mm	38mm	30gr	360x

Chave de caixa 1/2" com bit  
Llave de vaso 1/2" con punta



REF	⊕	∓	TIPO	FACES/ CARAS	📦	📄
1265505	5mm	55mm	CURTO/CORTA	Hex	78gr	200x
1265506	6mm	55mm	CURTO/CORTA	Hex	79gr	200x
1265507	7mm	55mm	CURTO/CORTA	Hex	81gr	200x
1265508	8mm	55mm	CURTO/CORTA	Hex	81gr	200x
1265510	10mm	55mm	CURTO/CORTA	Hex	88gr	200x
1265512	12mm	55mm	CURTO/CORTA	Hex	94gr	200x
1265514	14mm	55mm	CURTO/CORTA	Hex	105gr	200x
1265517	17mm	55mm	CURTO/CORTA	Hex	133gr	200x
1265519	19mm	55mm	CURTO/CORTA	Hex	141gr	200x
1261007	7mm	100mm	LONGO/LARGA	Hex	110gr	200x
1261405	5mm	140mm	LONGO/LARGA	Hex	135gr	200x
1262005	5mm	200mm	LONGO/LARGA	Hex	178gr	100x
1262006	6mm	200mm	LONGO/LARGA	Hex	179gr	100x
1262007	7mm	200mm	LONGO/LARGA	Hex	181gr	100x
1262008	8mm	200mm	LONGO/LARGA	Hex	181gr	100x
1262010	10mm	200mm	LONGO/LARGA	Hex	182gr	100x
1262012	12mm	200mm	LONGO/LARGA	Hex	235gr	100x
1265520	20mm	55mm	CURTO/CORTA	Torx	77gr	200x
1265525	25mm	55mm	CURTO/CORTA	Torx	77gr	200x
1265527	27mm	55mm	CURTO/CORTA	Torx	79gr	200x
1265530	30mm	55mm	CURTO/CORTA	Torx	79gr	200x
1265540	40mm	55mm	CURTO/CORTA	Torx	79gr	200x



REF	⊕	∓	TIPO	FACES/ CARAS	📦	📄
1265545	45mm	55mm	CURTO/CORTA	Torx	80gr	200x
1265550	50mm	55mm	CURTO/CORTA	Torx	81gr	200x
1265555	55mm	55mm	CURTO/CORTA	Torx	83gr	200x
1265560	60mm	55mm	CURTO/CORTA	Torx	91gr	200x
1265570	70mm	55mm	CURTO/CORTA	Torx	102gr	200x
1262045	45mm	200mm	LONGO/LARGA	Torx	179gr	100x
1262050	50mm	200mm	LONGO/LARGA	Torx	180gr	100x
1262055	55mm	200mm	LONGO/LARGA	Torx	181gr	100x
1262060	60mm	200mm	LONGO/LARGA	Torx	232gr	100x
1262070	70mm	200mm	LONGO/LARGA	Torx	293gr	100x
1215505	M5	55mm	CURTO/CORTA	xzn	78gr	200x
1215506	M6	55mm	CURTO/CORTA	xzn	78gr	200x
1215508	M8	55mm	CURTO/CORTA	xzn	79gr	200x
1215509	M9	55mm	CURTO/CORTA	xzn	81gr	200x
1215510	M10	55mm	CURTO/CORTA	xzn	82gr	200x
1215512	M12	55mm	CURTO/CORTA	xzn	91gr	200x
1215514	M14	55mm	CURTO/CORTA	xzn	100gr	200x
1215516	M16	55mm	CURTO/CORTA	xzn	124gr	200x
1212008	M8	200mm	LONGO/LARGA	xzn	179gr	100x
12120010	M10	200mm	LONGO/LARGA	xzn	181gr	100x
12120012	M12	200mm	LONGO/LARGA	xzn	232gr	100x
12120014	M14	200mm	LONGO/LARGA	xzn	291gr	100x

Chave de caixa isoladas VDE 1/2"  
Llave de vaso aislada VDE 1/2"









REF	⊕	∓	TIPO	FACES/ CARAS	📦	📄
150610	10mm	55mm	CURTO/CORTA	Hex	65gr	120x
150611	11mm	55mm	CURTO/CORTA	Hex	67gr	120x
150612	12mm	55mm	CURTO/CORTA	Hex	67gr	120x
150613	13mm	55mm	CURTO/CORTA	Hex	68gr	120x
150614	14mm	55mm	CURTO/CORTA	Hex	70gr	120x
150616	16mm	55mm	CURTO/CORTA	Hex	71gr	120x

REF	⊕	∓	TIPO	FACES/ CARAS	📦	📄
150617	17mm	55mm	CURTO/CORTA	Hex	80gr	120x
150618	18mm	55mm	CURTO/CORTA	Hex	91gr	120x
150619	19mm	55mm	CURTO/CORTA	Hex	83gr	120x
150622	22mm	55mm	CURTO/CORTA	Hex	95gr	120x
150624	24mm	55mm	CURTO/CORTA	Hex	102gr	120x
150627	27mm	57mm	CURTO/CORTA	Hex	128gr	120x



-  Chave caixa curta 3/4" hexagonal 20mm  
 Llave vaso 3/4" corta hexagonal 20mm







REF				
340620	20mm	48mm	200gr	50x





-  Chave em T umbrako  
 Llave en T umbrako





-  Chave em T torx  
 Llave en T torx





REF				
120408	8mm	307mm	100gr	48x
120410	10mm	307mm	110gr	48x

REF				
120540	T40	150mm	100gr	96x
120545	T45	200mm	200gr	48x

-  Aumento 3/8" 150mm  
 Alargadera 3/8" 150mm



REF			
4381	150mm	110gr	100x

-  Cardan universal impacto 1/2" CRMO  
 Cardán universal de impacto 1/2" CRMO



REF		
4543	170gr	50x

**ALICATES**

**ALICATES**

**02**

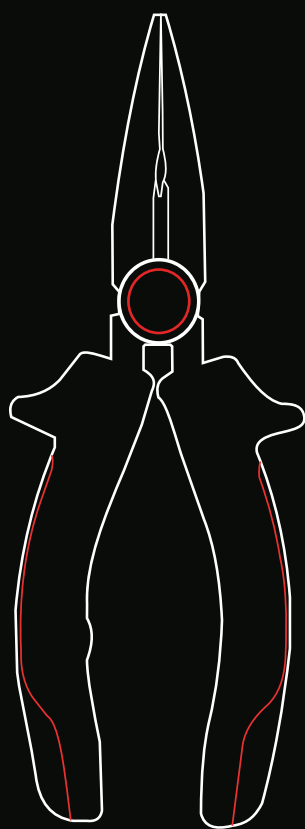

 <b>FAMÍLIA</b>	<b>PÁGINAS</b>
01 FERRAMENTA MANUAL	9-18
<b>02 ALICATES</b>	<b>21-22</b>
03 BITS E CONJUNTOS	25-28
04 FERRAMENTA ESPECÍFICA	31-37
05 FERRAMENTA CARROÇARIA	41-42
06 REGULAÇÃO E TESTE	45-48
07 FERRAMENTA MOTOR	51-52
08 KITS SINCRONIZAÇÃO	55-78
09 FERRAMENTA ELÉTRICA	81-82
10 FERRAMENTA PNEUMÁTICA	---
11 FERRAMENTA HIDRÁULICA	85-92
12 FERRAMENTA LUBRIFICAÇÃO	95-96
13 EQUIPAMENTO GARAGEM	99-112
RT ROUPA DE TRABALHO	115-116
MR MERCHANDISING	119-120
EP EXPOSITORES	---
LR LOCALIZAÇÃO REFERÊNCIAS	123-124

 <b>FAMILIA</b>	<b>PÁGINAS</b>
01 HERRAMIENTA MANUAL	9-18
<b>02 ALICATES</b>	<b>21-22</b>
03 PUNTAS Y CONJUNTOS	25-28
04 HERRAMIENTA ESPECÍFICA	31-37
05 HERRAMIENTA DE CARROCERIA	41-42
06 REGULACIÓN Y PRUEBAS	45-48
07 HERRAMIENTA PARA MOTOR	51-52
08 KITS CALADO	55-78
09 HERRAMIENTA ELÉCTRICA	81-82
10 HERRAMIENTA NEUMÁTICA	---
11 HERRAMIENTA HIDRÁULICA	85-92
12 HERRAMIENTA LUBRICACIÓN	95-96
13 EQUIPAMENTO PARA TALLER	99-112
RT ROPA DE TRABAJO	115-116
MR MERCHANDISING	119-120
EP EXPOSITORES	---
LR LOCALIZACIÓN REFERENCIAS	123-124

- Rebitador de porcas M3-M6
- Remachadora de tuercas M3-M6



**Características:**  
Corpo em alumínio fundido, cabo em ferro estampado com acabamento pintado a spray e punhos revestidos em PVC  
**Aplicação:** Adequado para porcas de rebite em alumínio nos tamanhos M3, M4, M5 e M6  
**Inclui:** (1x) Pistola de rebite para porcas, (1x) Alavanca de ajuste, (1x) Peça de porca M3, (1x) Peça de porca M4, (1x) Peça de porca M5, (1x) Peça de porca M6, (1x) Bocal e mandril roscado

**Características:**  
Cuerpo de aluminio fundido a presión, mango estampado en hierro con acabado pintado a presión y empuñaduras recubiertas de PVC  
**Aplicación:** Adequado para tuercas remachables de aluminio en tamaños M3, M4, M5 y M6.  
**Incluye:** (1x) Pistola para remaches, (1x) Palanca de ajuste, (1x) Pieza de tuerca M3, (1x) Pieza de tuerca M4, (1x) Pieza de tuerca M5, (1x) Pieza de tuerca M6, (1x) Boquilla y mandril roscado

REF	↔	📏	📦
3732	255mm	630gr	20x

- Rebitador manual com cabeça ajustável 360°
- Remachadora manual con cabeza en ángulo 360°



**Características:**  
Corpo em alumínio fundido, cabo em ferro estampado com acabamento pintado a spray e punhos revestidos em PVC.  
**Inclui:** 4 bicos para rebites de 2,4mm (3/32"), 3,2mm (1/8"), 4mm (5/32") e 4,8mm (3/16").  
Fornecido com uma chave para bicos

**Características:**  
Cuerpo de aluminio fundido a presión, mango estampado en hierro con acabado pintado a presión y empuñaduras recubiertas de PVC  
**Incluye:** 4 boquillas para remaches de 2,4mm (3/32"), 3,2mm (1/8"), 4mm (5/32") e 4,8mm (3/16").  
Se suministra con una llave para boquillas

REF	↔	📏	📦
3733	290mm	625gr	24x

- Rebitadora pneumática com acoplador 360°
- Remachadora neumática con acoplador de 360°



**Características:**  
Pressão de ar de funcionamento: 60-100psi (4,1-7bar)  
Tamanho mínimo da linha de ar: 3/8" ID  
Entrada de ar: 1/4" BSP  
Capacidade de rebitagem: 2,4, 3,2, 4,0, 4,8 e 6,4mm  
**Inclui:** (1x) Ferramenta de chave; (1x) Ferramenta de chave inglesa; (1x) Chave de boca; (1x) Tubo de escape; (1x) Conector giratório (rosca de 1/4"); (1x) acoplamento rápido de ar comprimido; Bicos de rebitagem (2,4; 3,2; 4,0; 4,8; 6,4mm); (3x) Conjuntos de garras de substituição; (1x) Distribuidor de óleo (vazio)

**Características:**  
Presión de aire de funcionamiento: 60-100 psi (4,1-7 bar)  
Tamaño mínimo de la línea de aire: 3/8« de diámetro interno  
Entrada de aire: 1/4» BSP  
Capacidad de remachado: 2,4, 3,2, 4,0, 4,8 y 6,4 mm  
**Incluye:** (1x) Herramienta de llave; (1x) Herramienta de llave inglesa; (1x) Llave fija; (1x) Tubo de escape; (1x) Conector giratorio (rosca de 1/4"); (1x) Acoplamiento de línea aérea; Piezas de nariz (2,4; 3,2; 4,0; 4,8; 6,4 mm); (3x) Piezas de repuesto para las mordazas; (1x) Dosificador de aceite (vacío)

NOTA: Foto figurativa  
NOTA: Foto ilustrativa

REF	↔	📏	📦
7542	275mm	1,85kg	10x



**BITS E CONJUNTOS**  
**PUNTAS Y CONJUNTOS**

**03**

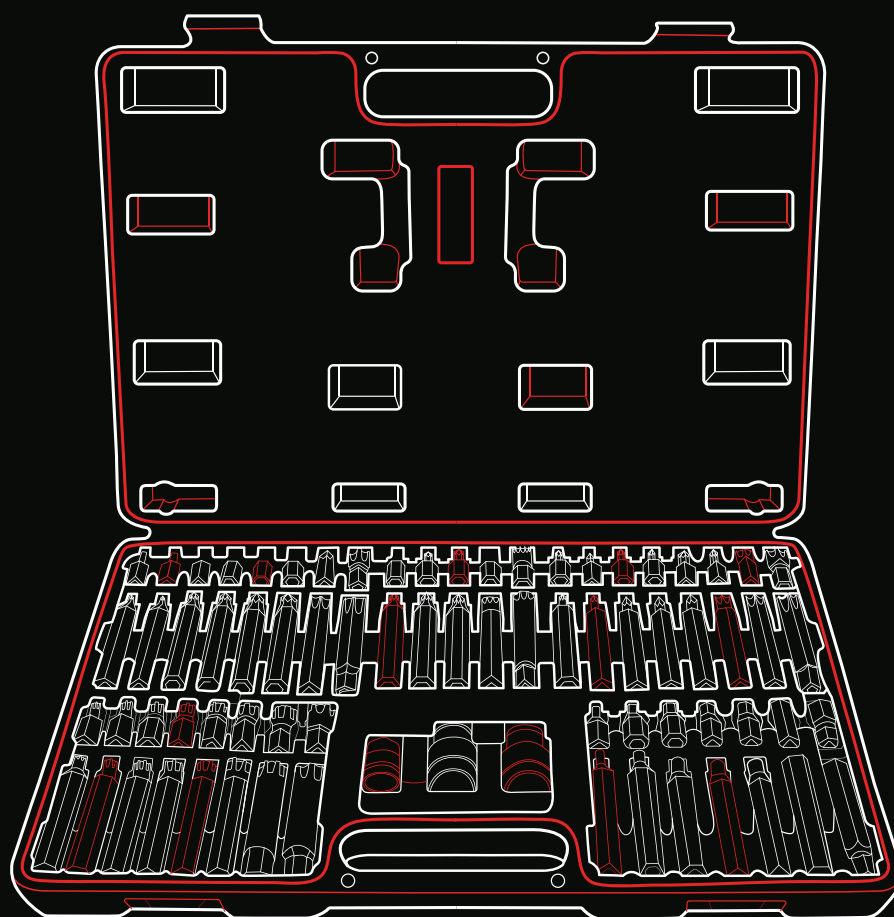











 <b>FAMÍLIA</b>	<b>PÁGINAS</b>
01 FERRAMENTA MANUAL	9-18
02 ALICATES	21-22
<b>03 BITS E CONJUNTOS</b>	<b>25-28</b>
04 FERRAMENTA ESPECÍFICA	31-37
05 FERRAMENTA CARROÇARIA	41-42
06 REGULAÇÃO E TESTE	45-48
07 FERRAMENTA MOTOR	51-52
08 KITS SINCRONIZAÇÃO	55-78
09 FERRAMENTA ELÉTRICA	81-82
10 FERRAMENTA PNEUMÁTICA	---
11 FERRAMENTA HIDRÁULICA	85-92
12 FERRAMENTA LUBRIFICAÇÃO	95-96
13 EQUIPAMENTO GARAGEM	99-112
RT ROUPA DE TRABALHO	115-116
MR MERCHANDISING	119-120
EP EXPOSITORES	---
LR LOCALIZAÇÃO REFERÊNCIAS	123-124

 <b>FAMILIA</b>	<b>PÁGINAS</b>
01 HERRAMIENTA MANUAL	9-18
02 ALICATES	21-22
<b>03 PUNTAS Y CONJUNTOS</b>	<b>25-28</b>
04 HERRAMIENTA ESPECÍFICA	31-37
05 HERRAMIENTA DE CARROCERIA	41-42
06 REGULACIÓN Y PRUEBAS	45-48
07 HERRAMIENTA PARA MOTOR	51-52
08 KITS CALADO	55-78
09 HERRAMIENTA ELÉCTRICA	81-82
10 HERRAMIENTA NEUMÁTICA	---
11 HERRAMIENTA HIDRÁULICA	85-92
12 HERRAMIENTA LUBRICACIÓN	95-96
13 EQUIPAMENTO PARA TALLER	99-112
RT ROPA DE TRABAJO	115-116
MR MERCHANDISING	119-120
EP EXPOSITORES	---
LR LOCALIZACIÓN REFERENCIAS	123-124

- Conjunto bits com roquete 1/4" 26pcs
- Conjunto de bits con roquete 1/4" 26pcs

















1x		1/4"
1x		1/4" x 50mm
11x		1/4": 4, 5, 6, 7, 8, 9, 10, 11, 12, 13, 14mm
3x	 	PH1, PH2, PH3
2x	 	4.0, 6.0mm
7x	 	T10, T15, T20, T25, T27, T30, T40
1x	 	S2



REF		
2030	500gr	20x

- Conjunto bits com roquete em T 1/4" 24pcs
- Conjunto de bits con roquete en T 1/4" 24pcs

























1x		1/4"
1x		Multifunções/ Multifunciones
1x	Adaptador para chave de caixa/ Adaptador para llave de vaso: 1/4" x 25mm	
3x	 	PH1, PH2, PH3
4x	 	3.0, 4.0, 5.0, 6.0mm
7x	 	T10, T15, T20, T25, T27, T30, T40
4x	 	S0, S1, S2, S3
3x	 	3.0, 4.0, 5.0mm

REF		
2031	439gr	20x

-  Conjunto bits com chave de fendas de roquete 1/4" 43pcs  
 Conjunto de bits con llave de fendas de roquete 1/4" 43pcs



1x	Chave de fendas com roquete de 1/4"/ Destornillador de carraca de 1/4"	
1x	Suporte magnético para bits/ Soporte magnético para puntas: 1/4" x 60mm	
1x	Adaptador para chave de caixa/ Adaptador para llave de vaso: 1/4" x 25mm	
4x		1/4": 5, 6, 8, 10mm
4x	 	PH0, PH1, PH2, PH3
4x	 	3.0, 4.0, 5.0, 6.0mm
6x	 	T9, T10, T15, T20, T25, T30
4x	 	TT20, TT25, TT27, TT30
5x	 	2.0, 2.5, 3.0, 4.0, 5.0mm
4x	 	PZ0, PZ1, PZ2, PZ3
4x	 	S0, S1, S2, S3
2x	 	TA18, TA27
2x	 	Y00, Y0
1	 	SP6

-  Jogo chaves anti-roubo 22pcs VAG
-  Juego de vasos para tornillos antirrobo VAG 22 pzs



 **Conteúdos:**  
 Chaves: N.º 521, n.º 522, n.º 523, n.º 524, n.º 525, n.º 526, n.º 527, n.º 528, n.º 529, n.º 530, n.º 531, n.º 532, n.º 533, n.º 534, n.º 535, n.º 536, n.º 537, n.º 538, n.º 539, n.º 540  
 Chave de caixa 1/2" DR. x 19mm (Hex) x 42mm (L)  
 Barra de libertação: 12mm (diâmetro) x 88mm (L)  
**Aplicações:**  
 UP Polo (2010-), Beetle (2012-), Golf (2009-), Jetta (2011-), EOS, Scirocco, Passat (2006-), Sharan, Touran, Tiguan  
**Código OEM:** T10313

 **Contenido:**  
 Llaves: N.º 521, n.º 522, n.º 523, n.º 524, n.º 525, n.º 526, n.º 527, n.º 528, n.º 529, n.º 530, n.º 531, n.º 532, n.º 533, n.º 534, n.º 535, n.º 536, n.º 537, n.º 538, n.º 539, n.º 540  
 Llave de vaso de 1/2" DR. x 19mm (hexagonal) x 42mm (largo)  
 Barra de desbloqueo: 12mm (diámetro) x 88mm (largo)  
**Aplicación:**  
 UP Polo (2010-), Beetle (2012-), Golf (2009-), Jetta (2011-), EOS, Scirocco, Passat (2006-), Sharan, Touran, Tiguan  
**Código OEM:** T10313

REF



3068



1kg



10x

-  Jogo chaves anti-roubo 22pcs BMW
-  Juego de vasos para tornillos antirrobo BMW 22 pzs



 **Conteúdos:**  
 Chaves: N.º 41, n.º 42, n.º 43, n.º 44, n.º 45, n.º 46, n.º 47, n.º 48, n.º 49, n.º 50, n.º 51, n.º 52, n.º 53, n.º 54, n.º 55, n.º 56, n.º 57, n.º 58, n.º 59, n.º 60  
 Chave de caixa 1/2" DR.  
 Barra de libertação  
**Material:** Aço carbono  
**Aplicações:** BMW: Série 1 F20/F21, Série 3 F30/F31, Série 4 F32/F34/F36, Série 5 F10/F11, Série 6 F12/F13 e Série 7 F01/F02/F04  
**Código OEM:** 36 2 010  
**Nota:** Torque recomendado max. de 120 Nm para evitar danificar as chaves

 **Contenido:**  
 Llaves: n.º 41, n.º 42, n.º 43, n.º 44, n.º 45, n.º 46, n.º 47, n.º 48, n.º 49, n.º 50, n.º 51, n.º 52, n.º 53, n.º 54, n.º 55, n.º 56, n.º 57, n.º 58, n.º 59, n.º 60  
 Llave de vaso 1/2" DR.  
 Barra de liberación  
**Material:** Acero al carbono  
**Aplicaciones:** BMW: Série 1 F20/F21, Série 3 F30/F31, Série 4 F32/F34/F36, Série 5 F10/F11, Série 6 F12/F13 e Série 7 F01/F02/F04  
**Código OEM:** 36 2 010  
**Nota:** Par de apriete máximo recomendado de 120 Nm para evitar dañar las llaves

REF

3069



950gr



10x



Jogo chaves anti-roubo 22pcs Audi

Juego de vasos para tornillos antirrobo Audi 22 pzs



**Conteúdos:**

Chaves: A, B, C, E, F, G, H, I, J, L, M, N, P, Q, R, S, T, V, W, X

Chave de caixa 21mm x 1/2" D

Barra de libertação: 1/2" Dr. x 21mm(Hex) x 39mm(L)

**Aplicações:** Audi

**Material:** Aço carbono

**Código OEM:** T40073



**Contenido:**

Llaves: A, B, C, E, F, G, H, I, J, L, M, N, P, Q, R, S, T, V, W, X

Llave de vaso 21mm x 1/2" D

Barra de liberación: 1/2" Dr. x 21mm (Hex) x 39mm (L)

**Aplicaciones:** Audi

**Material:** Acero al carbono

**Código OEM:** T40073

REF

3070



1kg



10x

FERRAMENTA ESPECÍFICA  
HERRAMIENTA ESPECÍFICA

04

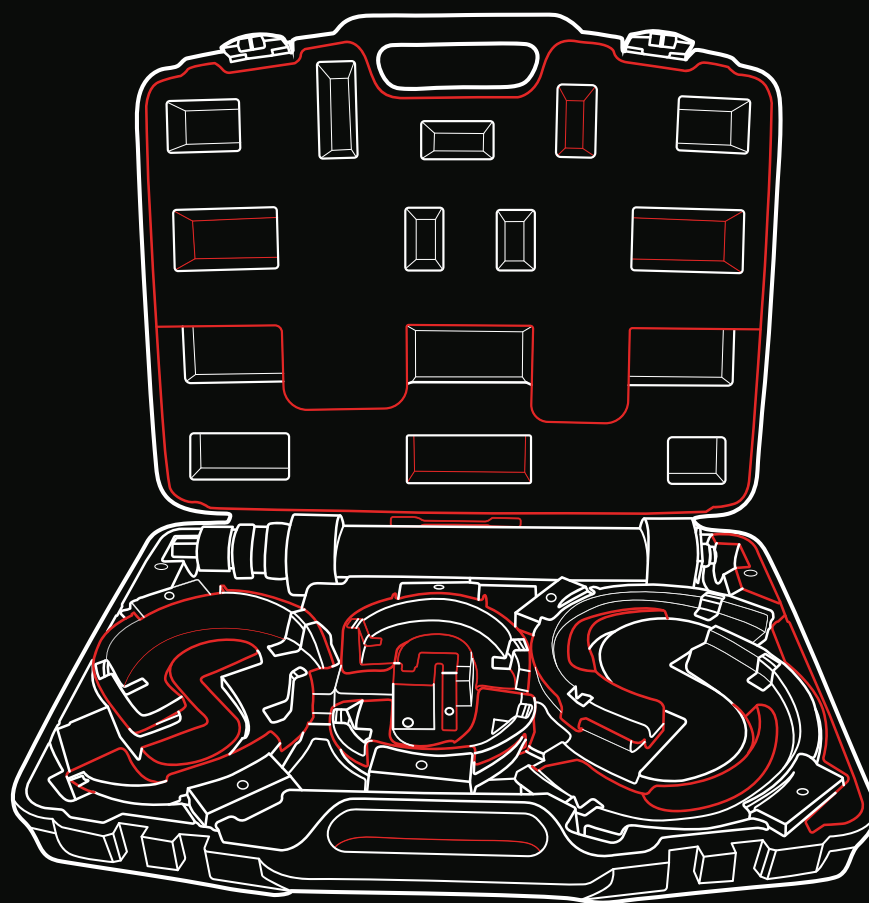

 <b>FAMÍLIA</b>	<b>PÁGINAS</b>
01 FERRAMENTA MANUAL	9-18
02 ALICATES	21-22
03 BITS E CONJUNTOS	25-28
<b>04 FERRAMENTA ESPECÍFICA</b>	<b>31-37</b>
05 FERRAMENTA CARROÇARIA	41-42
06 REGULAÇÃO E TESTE	45-48
07 FERRAMENTA MOTOR	51-52
08 KITS SINCRONIZAÇÃO	55-78
09 FERRAMENTA ELÉTRICA	81-82
10 FERRAMENTA PNEUMÁTICA	---
11 FERRAMENTA HIDRÁULICA	85-92
12 FERRAMENTA LUBRIFICAÇÃO	95-96
13 EQUIPAMENTO GARAGEM	99-112
RT ROUPA DE TRABALHO	115-116
MR MERCHANDISING	119-120
EP EXPOSITORES	---
LR LOCALIZAÇÃO REFERÊNCIAS	123-124

 <b>FAMILIA</b>	<b>PÁGINAS</b>
01 HERRAMIENTA MANUAL	9-18
02 ALICATES	21-22
03 PUNTAS Y CONJUNTOS	25-28
<b>04 HERRAMIENTA ESPECÍFICA</b>	<b>31-37</b>
05 HERRAMIENTA DE CARROCERIA	41-42
06 REGULACIÓN Y PRUEBAS	45-48
07 HERRAMIENTA PARA MOTOR	51-52
08 KITS CALADO	55-78
09 HERRAMIENTA ELÉCTRICA	81-82
10 HERRAMIENTA NEUMÁTICA	---
11 HERRAMIENTA HIDRÁULICA	85-92
12 HERRAMIENTA LUBRICACIÓN	95-96
13 EQUIPAMENTO PARA TALLER	99-112
RT ROPA DE TRABAJO	115-116
MR MERCHANDISING	119-120
EP EXPOSITORES	---
LR LOCALIZACIÓN REFERENCIAS	123-124

- Bandeja magnética 150mm
- Bandeja imantada 150mm



**Descrição:**  
**Base:** Inclui um ímã forte e uma camada circular de PVC para evitar riscos em superfícies  
**Material:** Fabricada em plástico ABS de alta qualidade, garantindo durabilidade e leveza

**Descripción:**  
**Parte inferior:** equipada con un imán fuerte y una capa circular de PVC para evitar arañazos en la superficie  
**Material:** fabricada con plástico ABS de alta calidad, lo que garantiza durabilidad y ligereza

REF	↔	📏	📦
9406	150mm	500gr	12x

- Chave magnética de 3/8" para montagem de amortecedor de suspensão para tesla
- Llave magnética de 3/8" para instalación del amortiguador de suspensión tesla



	Modelo 3 e Modelo Y
--	---------------------

Norma: DIN 3120 - ISO 1174

**Características:**  
 Diâmetro externo: 17mm  
 Tamanho da chave SW: 13mm  
 Chave quadrada (imperial): 3/8"

**Características:**  
 Diámetro exterior: 17mm  
 Tamaño de llave SW: 13mm  
 Conector cuadrado (imperial): 3/8"

REF	↔	📏	📦
6426	63mm	600gr	150x

- Extrator de rótulas para Land Rover e Jaguar
- Separador de junta esférica para Land Rover y Jaguar



	Land Rover, Jaguar
--	--------------------

**Características:**  
 Capacidade da mandíbula: 17mm  
 Abertura máxima: 50mm  
 Material: aço carbono  
**Dimensões:** 220 x 145 x 55mm

**Características:**  
 Capacidad de la mordaza: 17mm  
 Apertura máxima: 50mm  
 Material: acero al carbono  
**Dimensiones:** 220 x 145 x 55mm

REF	📏	📦
6332	3,6kg	4x



- Adaptador curvo e chave extrator injetores CDI pancada
- Adaptador curvo y llave extractora de inyectores CDI de golpes



**Características:**  
 Material: aço 45#  
 Adaptador curvo: 80mm  
 Extrator M12x1: 60mm

**Características:**  
 Material: acero 45#  
 Adaptador curvo: 80mm  
 Extractor M12x1: 60mm

REF	📏	📦
8472	308gr	60x

-  Sacarolamentos garra longa 300mm  
 Extractor de rodamentos garra larga 300mm



 **NOTA:** Foto figurativa  
 **NOTA:** Foto ilustrativa

 **Características:**  
 Material: aço 40Cr  
 Comprimento do veio: 240mm  
 Comprimento da garra: 300mm  
 Tamanho do encaixe hexagonal: 14mm  
 Intervalo mínimo e máximo: 10–50mm  
 Dureza: 45-50 HRC

 **Características:**  
 Material: acero 40Cr  
 Longitud del eje: 240mm  
 Longitud de la garra: 300mm  
 Tamaño del accionamiento hexagonal: 14mm  
 Rango mínimo y máximo: 10–50mm  
 Dureza: 45-50 HRC



REF



9327

1,12kg

10x



-  Kit remoção velas incandescentes pneumático  
 Juego de llave de impacto neumática para bujías de incandescencia



 **NOTA:** Foto figurativa  
 **NOTA:** Foto ilustrativa

 **Características:**  
 Velocidade livre: 10 000rpm  
 Binário: 1=10 Nm, 2=20 Nm, 3=30 Nm, 4=40 Nm  
 Entrada de ar: 1/4"  
 Consumo médio de ar: 150 L/min  
 Sistema de escape: traseiro  
 Pressão de ar recomendada: 90 psi

 **Características:**  
 Velocidad: 10 000rpm  
 Par: 1=10 Nm, 2=20 Nm, 3=30 Nm, 4=40 Nm  
 Entrada de aire: 1/4"  
 Consumo medio de aire: 150 L/min  
 Sistema de escape: trasero  
 Presión de aire recomendada: 90 psi

2x		50, 100mm
5x		8, 9, 10, 11, 12 mm
1x		1/4"D



REF



9322

1,93kg

10x

-  Kit instalação e remoção veio dualmotor EV  
 Kit de instalación y extracción del eje dualmotor EV



 **Descrição:**  
 Kit de instalação e remoção do veio do motor dual para veículos elétricos (EV)  
**Compatibilidade:** Tesla Model Y, Model 3, Model X; Jeep Wrangler; Honda Prologue; Hyundai / Kia; Chevrolet e GM  
 (Outros veículos também podem ser aplicáveis. Confirmar a referência OEM antes da utilização)

 **Descripción:**  
 Kit de instalación y extracción del eje del motor dual para vehículos eléctricos (EV)  
**Compatibilidad:** Tesla Model Y, Model 3, Model X; Jeep Wrangler; Honda Prologue; Hyundai / Kia; Chevrolet y GM  
 (Otros vehículos también pueden ser aplicables. Confirmar la referencia OEM antes de su uso)

REF



3127

8,5kg

2x

 Kit instalação para tampa traseira da caixa de velocidades Porsche PDK 718

 Kit de instalación para tapa trasera de la caja de cambios Porsche PDK 718



 **Descrição:**

Esta ferramenta é utilizada para remover a tampa traseira da transmissão de dupla embraiagem sem entrar em contacto com outras peças, sem causar danos às peças, podendo retirar rapidamente a tampa e melhorar a eficiência do trabalho

**Aplicação:**

Compatível com Porsche 918 911 718,  
Compatível com Porsche Panamera, Porsche Cayenne, Porsche Macan, com caixa de velocidades de dupla embraiagem PDK

 **Descripción:**

Esta herramienta se utiliza para retirar la carcasa trasera de la transmisión de doble embrague, no entra en contacto con otras piezas, no causa daños en las piezas, permite extraer rápidamente la carcasa y mejora la eficiencia del trabajo

**Aplicación:**

Compatible con Porsche 918, 911 y 718.  
Compatible con Porsche Panamera, Porsche Cayenne y Porsche Macan con caja de cambios de doble embrague PDK

REF

5321



6,5kg



2x

 Kit extrator de camisas de cilindro Diesel

 Juego de extractor de camisas de cilindro Diesel



 **Descrição:**

Concebido para extrair camisas de cilindro desgastadas em automóveis ligeiros ou veículos comerciais

**Aplicação:** Veículos pesados (ex.: Daimler Benz, camiões MAN, etc)  
Camisas de cilindro com diâmetro de  $\phi 60-160$  mm, camisas de motores automóveis e estacionários, e outras peças

 **Descripción:**

Diseñado para extraer camisas de cilindro desgastadas en automóviles ligeros o vehículos comerciales

**Aplicación:** Vehículos pesados (por ejemplo, Daimler Benz, camiones MAN, etc)  
Camisas de cilindro con un diámetro de  $\phi 60-160$  mm, camisas de motores de automóvil y estacionarios, y otras piezas

REF



2810



9kg



2x

 Jogo cortantes para injetores diesel 17pcs  
 Juego de cortadores para inyectoros diesel 17pzs



 **Descrição:**  
 Conjunto concebido para limpar e descarbonizar os assentos dos injetores durante a substituição  
 Ajuda a evitar fugas de compressão resultantes de injetores mal instalados

Fresas fabricadas em aço 35CR-MO de elevada resistência

**Conteúdo:**

- 14mm x 14mm Fresa plana
- 15mm x 19mm Fresa plana
- 15,5mm x 15,5mm Fresa plana
- 15,5 +mm x 15,5mm Fresa angular
- 17mm x 17mm Fresa angular
- 17mm x 17mm Fresa plana
- 17mm x 17,5mm Fresa plana
- 17mm x 19mm Fresa plana
- 17mm x 19,5mm Fresa plana
- 17mm x 20mm Fresa plana
- 17mm x 21mm Fresa angular
- 17,5mm x 20,5mm Fresa plana
- 19mm x 21,5mm Fresa plana
- Punho em T
- Piloto hexagonal 19mm x 170mm
- Cortador 15,5mm x 225mm
- Chave hexagonal 2,5mm

 **Descripción:**  
 Conjunto diseñado para limpiar y descarbonizar los asientos de los inyectoros durante su sustitución  
 Ayuda a evitar fugas de compresión resultantes de inyectoros mal instalados

Fresas fabricadas en acero 35CR-MO de alta resistencia

**Contenido:**

- Fresa plana 14mm x 14mm
- Fresa plana 15mm x 19mm
- Fresa plana 15,5mm x 15,5mm
- Fresa angular 15,5mm x 15,5mm
- Fresa angular 17mm x 17mm
- Fresa plana 17mm x 17mm
- Fresa plana 17mm x 17,5mm
- Fresa plana 17mm x 19mm
- Fresa plana 17mm x 19,5mm
- Fresa plana 17mm x 20mm
- Fresa angular 17mm x 21mm
- Fresa angular 17,5mm x 20,5mm
- Fresa plana 19mm x 21,5mm
- Mango en T
- Piloto hexagonal 19mm x 170mm
- Cortador 15,5mm x 225mm
- Llave hexagonal 2,5mm

REF

1921





2,1kg



5x

 Kit instalação vedante cambota frontal para JLR TDV6  
 Kit de montaje del retén frontal del cigüeñal para JLR T DV6



	TDV6 3.0L
	Land Rover Discovery 3/4, Range Rover Sport, Range Rover (2013)
	1102415/LR002452, 303-1121, 303-1122

 **NOTA:** Foto figurativa  
**NOTA:** Foto ilustrativa

 **Descrição:**  
 Concebido para permitir a instalação correta da vedação do óleo do virabrequim dianteiro sem danificar o lábio de vedação.

 **Descripción:**  
 Diseñado para permitir el montaje correcto del sello de aceite del cigüeñal delantero sin dañar el labio de sellado

REF

6491



4kg



10x

 Kit instalação caixa de velocidades Mercedes 724.2

 Kit de instalación de transmisión Mercedes 724.2





 **NOTA:** Foto figurativa  
**NOTA:** Foto ilustrativa

 **Descrição:**  
Para desmontar/montar o estator de forma correta e segura  
Desenvolvido para garantir uma reparação profissional e evitar danos na transmissão

**Aplicação:**  
Este kit de ferramentas é adequado para o Mercedes 724.2 Hybrid 7-Speed

 **Descripción:**  
Para desmontar/montar el estator de forma correcta y segura  
Este kit de herramientas ha sido desarrollado para garantizar una reparación profesional y evitar daños en la transmisión

**Aplicación:**  
Este kit de herramientas es adecuado para el Mercedes 724.2 Hybrid 7-Speed

REF		
5322	19kg	1x

 Kit extrator hidráulico para casquilhos silentblock 19 pcs

 Kit extractor hidráulico de silentblocks con ranura 19 pzs



 **Descrição:**  
(1x) Cilindro hidráulico: 12T  
(1x) Manga coletora: 90x166mm  
(2x) Anel de suporte (remoção): 64x20mm, 74x20mm  
(3x) Peça de pressão (remoção): 49x34mm, 59x34mm, 66x35mm  
(1x) Bloco de fixação: 90x54mm  
(3x) Conjunto de meia concha: 51x54mm, 60x54mm, 68x54mm  
(1x) Bloco de inserção: 78x35mm  
(2x) Contra-rolamento (montagem): 78x37mm, 98x36mm  
(3x) Anel de suporte (montagem): 103x26mm, 108x25mm, 108x26mm  
(1x) Eixo (remoção) M16x2.0: L=195mm  
(1x) Eixo (montagem) M16x2.0: L=280mm

**Adequado para:**  
51mm - para Volvo FM12  
60mm - para DB / Renault (430/450/460)  
68mm - para MANN-TGA (140/414/460) mola do eixo dianteiro ROR, SAF

 **Descripción:**  
(1x) Cilindro hidráulico: 12T  
(1x) Manguito colector: 90x166mm  
(2x) Anillo de soporte (desmontaje): 64x20mm, 74x20mm  
(3x) Pieza de presión (desmontaje): 49x34mm, 59x34mm, 66x35mm  
(1x) Bloque de fijación: 90x54mm  
(3x) Juego de semicarcasas: 51x54mm, 60x54mm, 68x54mm  
(1x) Bloque de inserción: 78x35mm  
(2x) Contracojinete (montaje): 78x37mm, 98x36mm  
(3x) Anillo de soporte (montaje): 103x26mm, 108x25mm, 108x26mm  
(1x) Eje (desmontaje) M16x2.0: L=195mm  
(1x) Eje (montaje) M16x2.0: L=280mm

**Adecuado para:**  
51mm - para Volvo FM12  
60mm - para DB / Renault (430/450/460)  
68mm - para MAN-TGA (140/414/460) muelle del eje delantero ROR, SAF

REF		
6333	7kg	50x

 Kit colocação vedante frontal cambota BMW B48/B58  
 Instalador del retén frontal del cigüeñal de BMW B48 B58



BMW B48B/B47D/B57/B58

 **NOTA:** Foto figurativa  
 **NOTA:** Foto ilustrativa

 **Descrição:**  
 Especialmente concebido para proteger e instalar o retentor de óleo do veio de manivelas dianteiro na posição correta

Número BM: 118800 (0496127)

 **Descripción:**  
 Diseñado especialmente para proteger e instalar el sello de aceite del cigüeñal delantero en la posición correcta

Número BM: 118800 (0496127)

REF



6456



900gr



10x

 Máquina limpeza e teste injectores GDI/EFI/FSI  
 Máquina de limpieza y prueba de inyectores GDI/EFI/FSI



 **Descrição:**  
 Fonte de alimentação: AC 110/220V ±10%  
 Frequência: 50Hz/60Hz  
 Capacidade do depósito de limpeza: 2000 ml  
 Frequência de limpeza ultrassónica: 28 KHz  
 Intervalo de rotação: 0–7500 r/min  
 Largura de pulso PWM: 0–40,0 ms (passo de 0,1 ms)  
 Temporização: 0–10 min  
 Número de injeções: 0–9900 vezes (passo de 100 ms)  
 Pressão do sistema: 0–0,8 MPa  
 Humidade relativa: <85%  
 Temperatura ambiente: 0°C~40°C  
 Intensidade do campo magnético externo: <400 A/m

 **Descripción:**  
 Fuente de alimentación: AC 110/220V ±10%  
 Frecuencia: 50Hz/60Hz  
 Capacidad del depósito de limpieza: 2000 ml  
 Frecuencia de limpieza ultrassónica: 28 KHz  
 Rango de rotación: 0–7500 r/min  
 Ancho de pulso PWM: 0–40,0 ms (paso de 0,1 ms)  
 Temporizador: 0–10 min  
 Número de inyecciones: 0–9900 veces (paso de 100 ms)  
 Presión del sistema: 0–0,8 MPa  
 Humedad relativa: <85%  
 Temperatura ambiente: 0°C~40°C  
 Intensidad del campo magnético externo: <400 A/m

REF

4406



18,8kg



1x

-  Bomba encher óleo em transmissões 10L com 13 adaptadores
-  Bomba de llenado de aceite para transmisiones 10L con 13 adaptadores



 **NOTA:** Foto figurativa  
**NOTA:** Foto ilustrativa

 **Descrição:**

O kit inclui 13 adaptadores para uma ampla gama de modelos de transmissão automática:

- ATF-101 FORD 1/8 – 27 (NPT)
- ATF-102 Universal BMW, Honda, Nissan, etc.
- ATF-103 VW/Audi. Skoda.
- ATF-104 VW/Audi, Porsche
- ATF-105 VW/Audi, Mini Cooper M10 x 1.0,
- ATF-106 VW/Audi DSG M24 x 1.5,
- ATF-107 VW/Audi CVT M22 x 1.5,
- ATF-108 Mercedes M12 x 1.5,
- ATF-109 V/W. Skoda M18 x 1.5
- ATF-110 Audi/VW, Skoda M30 x1.5
- ATF-111 Universal Flexible 300mm, Honda, Hyundai, Kia, etc.
- ATF-112 Volvo 5/16 – 24 (UNF)
- ATF-113 Toyota, Lexus, BMW 7 Série M18 x 1.5

**Características:**

Entrada de ar: 1/4”  
Pressão de trabalho: de 30 a 70 PSI (de 2 a 4,8 BAR)  
Capacidade do tanque: 10L

 **Descripción:**

El kit incluye 13 adaptadores para una amplia gama de modelos de transmisión automática:

- ATF-101 FORD 1/8 – 27 (NPT)
- ATF-102 Universal BMW, Honda, Nissan, etc.
- ATF-103 VW/Audi. Skoda.
- ATF-104 VW/Audi, Porsche
- ATF-105 VW/Audi, Mini Cooper M10 x 1.0,
- ATF-106 VW/Audi DSG M24 x 1.5,
- ATF-107 VW/Audi CVT M22 x 1.5,
- ATF-108 Mercedes M12 x 1.5,
- ATF-109 V/W. Skoda M18 x 1.5
- ATF-110 Audi/VW, Skoda M30 x1.5
- ATF-111 Universal Flexible 300mm, Honda, Hyundai, Kia, etc.
- ATF-112 Volvo 5/16 – 24 (UNF)
- ATF-113 Toyota, Lexus, BMW 7 Serie M18 x 1.5

**Características:**

Entrada de aire: 1/4”  
Presión de trabajo: de 30 a 70 PSI (de 2 a 4,8 BAR)  
Capacidad del depósito: 10L

REF

5355



3,75kg





1x



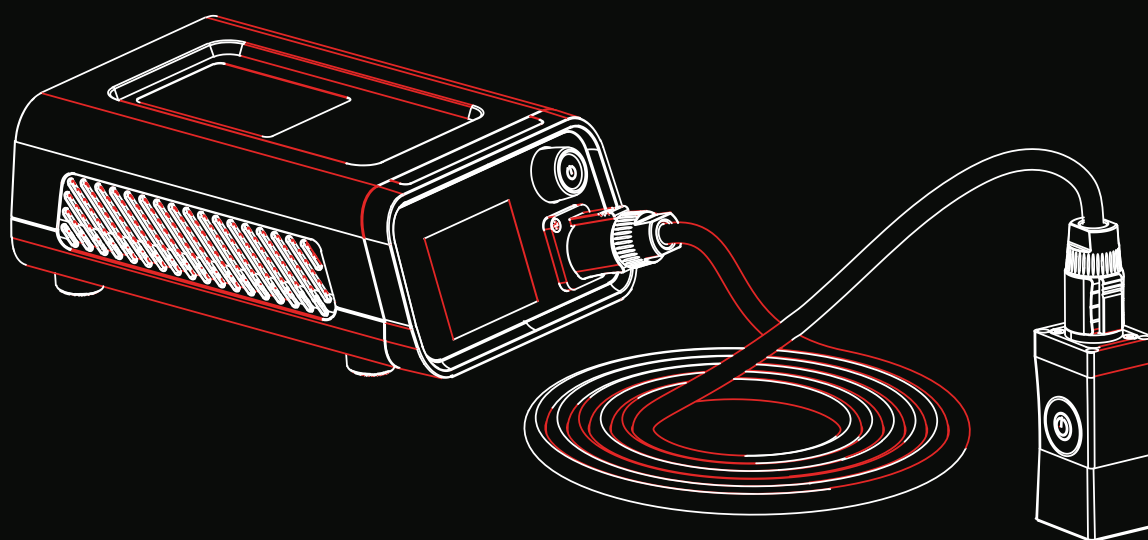

FERRAMENTA CARROÇARIA  
HERRAMIENTA DE CARROCERIA

05



 <b>FAMÍLIA</b>	<b>PÁGINAS</b>
01 FERRAMENTA MANUAL	9-18
02 ALICATES	21-22
03 BITS E CONJUNTOS	25-28
04 FERRAMENTA ESPECÍFICA	31-37
<b>05 FERRAMENTA CARROÇARIA</b>	<b>41-42</b>
06 REGULAÇÃO E TESTE	45-48
07 FERRAMENTA MOTOR	51-52
08 KITS SINCRONIZAÇÃO	55-78
09 FERRAMENTA ELÉTRICA	81-82
10 FERRAMENTA PNEUMÁTICA	---
11 FERRAMENTA HIDRÁULICA	85-92
12 FERRAMENTA LUBRIFICAÇÃO	95-96
13 EQUIPAMENTO GARAGEM	99-112
RT ROUPA DE TRABALHO	115-116
MR MERCHANDISING	119-120
EP EXPOSITORES	---
LR LOCALIZAÇÃO REFERÊNCIAS	123-124

 <b>FAMILIA</b>	<b>PÁGINAS</b>
01 HERRAMIENTA MANUAL	9-18
02 ALICATES	21-22
03 PUNTAS Y CONJUNTOS	25-28
04 HERRAMIENTA ESPECÍFICA	31-37
<b>05 HERRAMIENTA DE CARROCERIA</b>	<b>41-42</b>
06 REGULACIÓN Y PRUEBAS	45-48
07 HERRAMIENTA PARA MOTOR	51-52
08 KITS CALADO	55-78
09 HERRAMIENTA ELÉCTRICA	81-82
10 HERRAMIENTA NEUMÁTICA	---
11 HERRAMIENTA HIDRÁULICA	85-92
12 HERRAMIENTA LUBRICACIÓN	95-96
13 EQUIPAMENTO PARA TALLER	99-112
RT ROPA DE TRABAJO	115-116
MR MERCHANDISING	119-120
EP EXPOSITORES	---
LR LOCALIZACIÓN REFERENCIAS	123-124

-  Suporte de porta automóvel
-  Soporte de puerta de automóvil



 **NOTA:** Foto figurativa

 **NOTA:** Foto ilustrativa

 **Descrição:**  
Suporte de portas com rotação de 360° e inclinação de 5° para fácil alinhamento  
Barras laterais removíveis com revestimento protetor adaptam-se a portas maiores e evitam danos na superfície  
Ideal para remoção, instalação e fixação de portas com componentes elétricos

**Características:**

Medidas: 625x380x520mm  
Capacidade: 30kg

 **Descripción:**  
Soporte de puertas con giro de 360° e inclinación de 5° para un alineamiento fácil  
Barras laterales desmontables con revestimiento protector se adaptan a puertas más grandes y evitan daños en la superficie  
Ideal para extraer, instalar y sujetar puertas con componentes eléctricos

**Características:**

Medidas: 625x380x520mm  
Capacidad: 30kg

REF

4301



6.6kg



1x



REGULAÇÃO E TESTE  
REGULACIÓN Y PRUEBAS

06

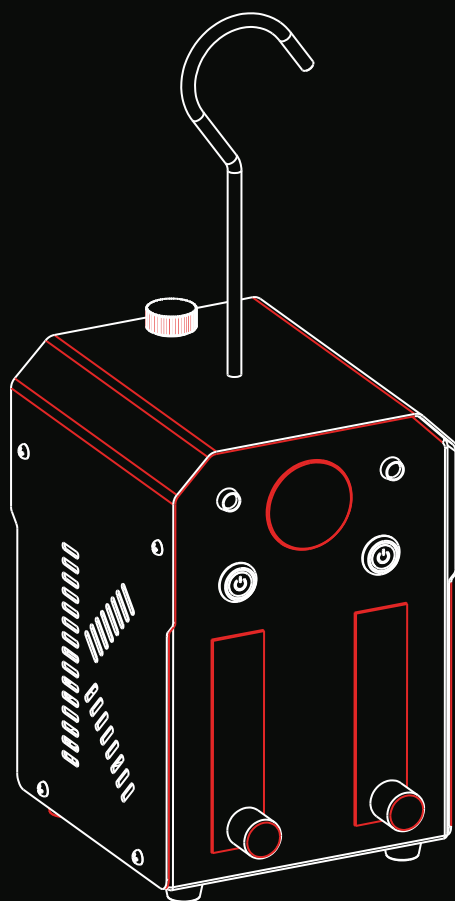



 <b>FAMÍLIA</b>	<b>PÁGINAS</b>
01 FERRAMENTA MANUAL	9-18
02 ALICATES	21-22
03 BITS E CONJUNTOS	25-28
04 FERRAMENTA ESPECÍFICA	31-37
05 FERRAMENTA CARROÇARIA	41-42
<b>06 REGULAÇÃO E TESTE</b>	<b>45-48</b>
07 FERRAMENTA MOTOR	51-52
08 KITS SINCRONIZAÇÃO	55-78
09 FERRAMENTA ELÉTRICA	81-82
10 FERRAMENTA PNEUMÁTICA	---
11 FERRAMENTA HIDRÁULICA	85-92
12 FERRAMENTA LUBRIFICAÇÃO	95-96
13 EQUIPAMENTO GARAGEM	99-112
RT ROUPA DE TRABALHO	115-116
MR MERCHANDISING	119-120
EP EXPOSITORES	---
LR LOCALIZAÇÃO REFERÊNCIAS	123-124

 <b>FAMILIA</b>	<b>PÁGINAS</b>
01 HERRAMIENTA MANUAL	9-18
02 ALICATES	21-22
03 PUNTAS Y CONJUNTOS	25-28
04 HERRAMIENTA ESPECÍFICA	31-37
05 HERRAMIENTA DE CARROCERIA	41-42
<b>06 REGULACIÓN Y PRUEBAS</b>	<b>45-48</b>
07 HERRAMIENTA PARA MOTOR	51-52
08 KITS CALADO	55-78
09 HERRAMIENTA ELÉCTRICA	81-82
10 HERRAMIENTA NEUMÁTICA	---
11 HERRAMIENTA HIDRÁULICA	85-92
12 HERRAMIENTA LUBRICACIÓN	95-96
13 EQUIPAMENTO PARA TALLER	99-112
RT ROPA DE TRABAJO	115-116
MR MERCHANDISING	119-120
EP EXPOSITORES	---
LR LOCALIZACIÓN REFERENCIAS	123-124

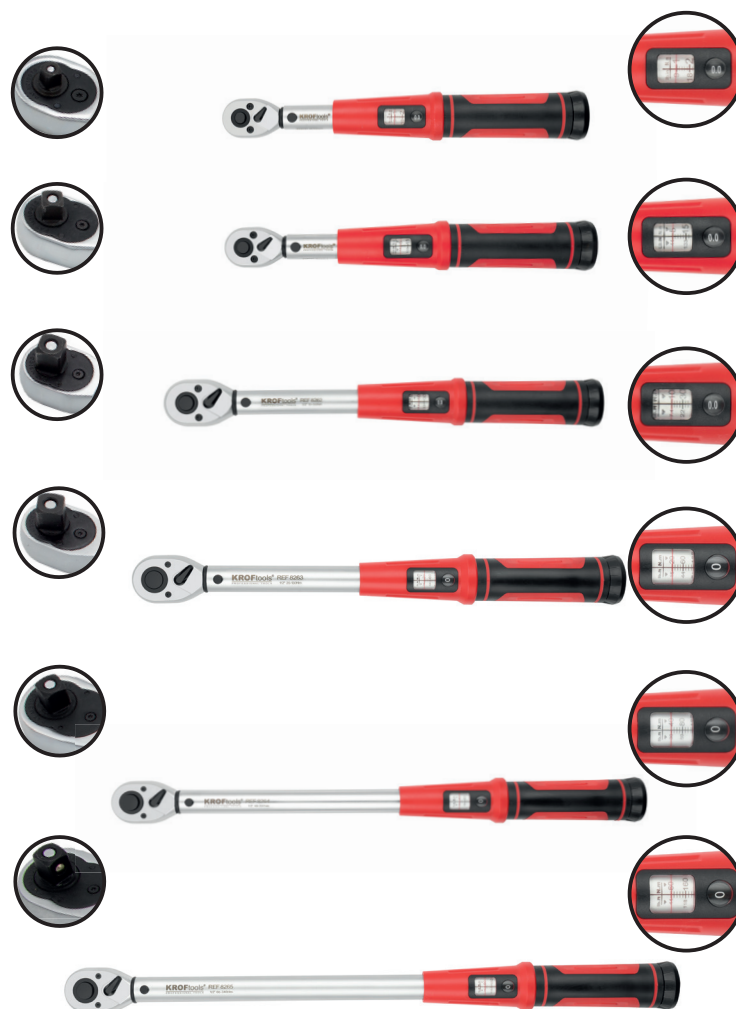
Chaves dinamométricas  
Llaves dinamométricas



REF	◇	Nm	K-H	📏	📦
8260	1/4"	1-5	253mm	700gr	10x
8261	3/8"	5-25	253mm	710gr	10x
8262	1/2"	10-50	310mm	870gr	10x
8263	1/2"	20-130	425mm	1,58kg	10x
8264	1/2"	40-200	500mm	2kg	6x
8265	1/2"	60-340	555mm	2,10kg	6x

 Teste fugas do turbo com manómetro 31-110mm  

 Comprobador de fugas sistema turbo con manómetro 31-110mm



**Características:**  
 Medida da caixa: 520x460x110mm  
 Intervalo de pressão do manómetro: 0-80psi  
 Medidas dos adaptadores: 31/38, 46/51, 55/60, 65/70, 75/80, 85/90, 95/100, 105/110mm

**Características:**  
 Medida de la caja: 520x460x110mm  
 Intervalo de presión del manómetro: 0-80psi  
 Medidas de los adaptadores: 31/38, 46/51, 55/60, 65/70, 75/80, 85/90, 95/100, 105/110mm

REF



4491



6,15kg



1x

 Teste fugas do turbo com manómetro 110-130mm  

 Comprobador de fugas sistema turbo con manómetro 110-130mm



**Características:**  
 Medida da caixa: 480x360x110mm  
 Intervalo de pressão do manómetro: 0-80psi  
 Medidas dos adaptadores: 105/110, 115/120, 125/130mm

**Características:**  
 Medida de la caja: 480x360x110mm  
 Intervalo de presión del manómetro: 0-80psi  
 Medidas de los adaptadores: 105/110, 115/120, 125/130mm

REF



4492









4,4kg





5x

 **Detetor de fugas de fumo 8L/min 65W**  
 **Detector de fugas de humo 8L/min 65W**



8x	
8x	
1x	
1x	
1x	
1x	
1x	
1x	
1x	
1x	

 **Características:**  
Alimentação: DC12V  
Pressão de saída do ar: 19–23psi  
Caudal de ar: 8L/min  
Geração de ar: bomba interna  
Capacidade do reservatório de óleo: 30ml  
Dimensões (CxLxA): 140x150x220mm

 **Características:**  
Alimentación: DC12V (toma de automóvil)  
Presión de salida de aire: 19–23psi  
Caudal de aire: 8L/min  
Generación de aire: bomba interna  
Capacidad del depósito de aceite de prueba: 30ml  
Dimensiones (LxAnxAI): 140x150x220mm

REF  
8729

  
3,2kg

  
4x



FERRAMENTA MOTOR

HERRAMIENTA PARA MOTOR

07



**KROFtools**<sup>®</sup>  
PROFESSIONAL TOOLS

 <b>FAMÍLIA</b>	<b>PÁGINAS</b>
01 FERRAMENTA MANUAL	9-18
02 ALICATES	21-22
03 BITS E CONJUNTOS	25-28
04 FERRAMENTA ESPECÍFICA	31-37
05 FERRAMENTA CARROÇARIA	41-42
06 REGULAÇÃO E TESTE	45-48
<b>07 FERRAMENTA MOTOR</b>	<b>51-52</b>
08 KITS SINCRONIZAÇÃO	55-78
09 FERRAMENTA ELÉTRICA	81-82
10 FERRAMENTA PNEUMÁTICA	---
11 FERRAMENTA HIDRÁULICA	85-92
12 FERRAMENTA LUBRIFICAÇÃO	95-96
13 EQUIPAMENTO GARAGEM	99-112
RT ROUPA DE TRABALHO	115-116
MR MERCHANDISING	119-120
EP EXPOSITORES	---
LR LOCALIZAÇÃO REFERÊNCIAS	123-124

 <b>FAMILIA</b>	<b>PÁGINAS</b>
01 HERRAMIENTA MANUAL	9-18
02 ALICATES	21-22
03 PUNTAS Y CONJUNTOS	25-28
04 HERRAMIENTA ESPECÍFICA	31-37
05 HERRAMIENTA DE CARROCERIA	41-42
06 REGULACIÓN Y PRUEBAS	45-48
<b>07 HERRAMIENTA PARA MOTOR</b>	<b>51-52</b>
08 KITS CALADO	55-78
09 HERRAMIENTA ELÉCTRICA	81-82
10 HERRAMIENTA NEUMÁTICA	---
11 HERRAMIENTA HIDRÁULICA	85-92
12 HERRAMIENTA LUBRICACIÓN	95-96
13 EQUIPAMENTO PARA TALLER	99-112
RT ROPA DE TRABAJO	115-116
MR MERCHANDISING	119-120
EP EXPOSITORES	---
LR LOCALIZACIÓN REFERENCIAS	123-124

Chave filtro óleo 72mm Ford ecoboost 1.0, 1.1, 2.0  
 Extractor filtro aceite 72mm Ford ecoboost 1.0, 1.1, 2.0



	Ford 1.0L, 1.1L e 2.0L
	EcoBoost, B-Max, C-Max, EcoSport, Fiesta, Active, Focus, Grand C-Max, Grand Tourneo, Connect, Mondeo, S-Max, Galaxy, Tourneo Connect, Tourneo Courier, Transit Connect, Transit Courier

**Características:**  
 Tamanho: 72mm x 14 ranhuras  
 Quadra: 1/2"

**Características:**  
 Tamaño: 72mm x 14 estrías  
 Accionamiento: cuadrado de 1/2"

REF			
6651	72mm	353gr	32x



Chave filtro óleo 1/2" 63,8mm Tesla  
 Llave para filtro de aceite 1/2" 63,8mm para Tesla



	Tesla
--	-------

NOTA: Foto figurativa  
 NOTA: Foto ilustrativa

REF			
6652	63,8mm	300gr	40x

-  Kit tampas drenagem óleo 16pcs  
 Kit tapones de drenaje de aceite 16pzs



Volkswagen  
 Audi  
 Porsche  
 BMW  
 Ford  
 Entre outros/ entre otros

 **NOTA:** Foto figurativa

**NOTA:** Foto ilustrativa

 **Descrição:**  
 Ferramenta para bujão de drenagem  
 Retira ou instala facilmente o bujão de drenagem com uma única meia volta  
**Material:** nylon + aço 45#

**Componentes:**

(1x) Cabo em T  
 (3x) Tampão Ford  
 (3x) Tampão PSA  
 (3x) Tampão VAG  
 (3x) Tampão BMW  
 (1x) adaptador de rosca hexagonal  
 (1x) adaptador de rosca hexagonal curto  
 (1x) Peça roscada hexagonal com cabeça em T

 **Descripción:**  
 Herramienta para tapones de drenaje  
 Fácil de quitar o instalar el tapón de drenaje con una sola media vuelta  
**Material:** nylon + acero 45#

**Componentes:**

(1x) Mango en T  
 (3x) Tapón Ford  
 (3x) Tapón PSA  
 (3x) Tapón VAG  
 (3x) Tapón BMW  
 (1x) Adapte Rosca Hexagonal  
 (1x) Inserto Rosca Hexagonal Corto  
 (1x) Pieza Roscada Hexagonal en T



REF



7006

5,75kg

5x

-  Chave filtro de combustível 3/8" Mercedes CDI  
 Llave para filtro de combustible 3/8" Mercedes CDI



Mercedes CDI

 **NOTA:** Foto figurativa

**NOTA:** Foto ilustrativa

 **Descrição:**  
 Ideal para soltar e apertar a tampa do filtro de combustível em filtros de difícil acesso

**Características:**

Encaixe em polegadas: 3/8"  
 Altura: 70mm  
 Norma: DIN 3120, ISO 1174

 **Descripción:**  
 Ideal para soltar y apretar la tapa del filtro de combustible en filtros de difícil acceso

**Características:**

Accionamiento en pulgadas: 3/8"  
 Altura: 70mm  
 Norma: DIN 3120, ISO 1174

REF



6653

2,4kg

20x

**KITS SINCRONIZAÇÃO**  
**KITS CALADO**

**08**

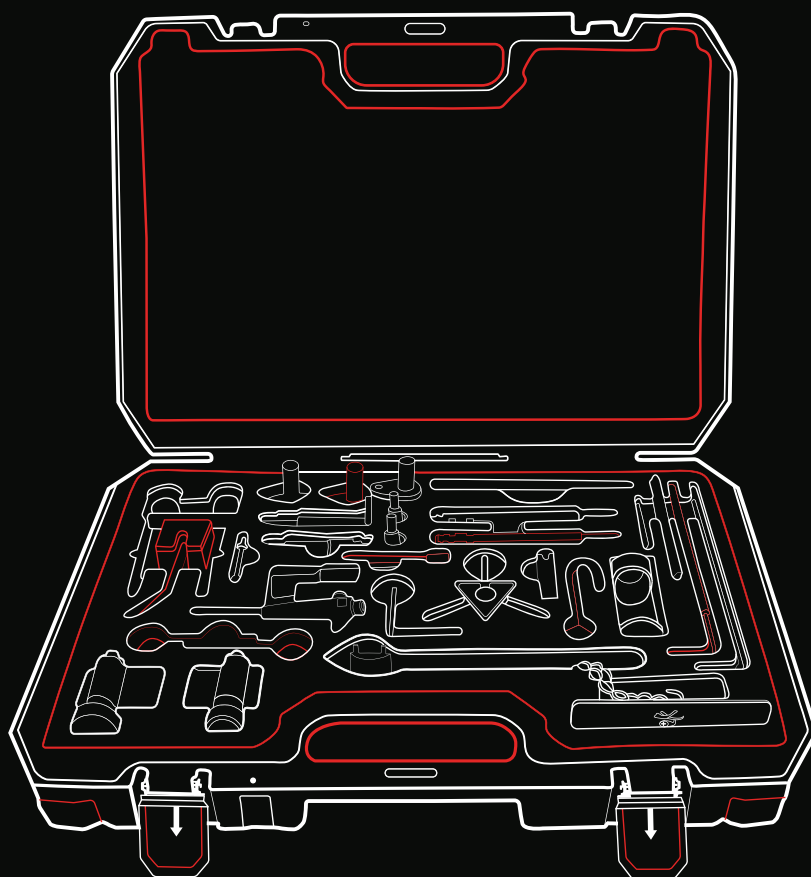



 <b>FAMÍLIA</b>	<b>PÁGINAS</b>
01 FERRAMENTA MANUAL	9-18
02 ALICATES	21-22
03 BITS E CONJUNTOS	25-28
04 FERRAMENTA ESPECÍFICA	31-37
05 FERRAMENTA CARROÇARIA	41-42
06 REGULAÇÃO E TESTE	45-48
07 FERRAMENTA MOTOR	51-52
<b>08 KITS SINCRONIZAÇÃO</b>	<b>55-78</b>
09 FERRAMENTA ELÉTRICA	81-82
10 FERRAMENTA PNEUMÁTICA	---
11 FERRAMENTA HIDRÁULICA	85-92
12 FERRAMENTA LUBRIFICAÇÃO	95-96
13 EQUIPAMENTO GARAGEM	99-112
RT ROUPA DE TRABALHO	115-116
MR MERCHANDISING	119-120
EP EXPOSITORES	---
LR LOCALIZAÇÃO REFERÊNCIAS	123-124

 <b>FAMILIA</b>	<b>PÁGINAS</b>
01 HERRAMIENTA MANUAL	9-18
02 ALICATES	21-22
03 PUNTAS Y CONJUNTOS	25-28
04 HERRAMIENTA ESPECÍFICA	31-37
05 HERRAMIENTA DE CARROCERIA	41-42
06 REGULACIÓN Y PRUEBAS	45-48
07 HERRAMIENTA PARA MOTOR	51-52
<b>08 KITS CALADO</b>	<b>55-78</b>
09 HERRAMIENTA ELÉCTRICA	81-82
10 HERRAMIENTA NEUMÁTICA	---
11 HERRAMIENTA HIDRÁULICA	85-92
12 HERRAMIENTA LUBRICACIÓN	95-96
13 EQUIPAMENTO PARA TALLER	99-112
RT ROPA DE TRABAJO	115-116
MR MERCHANDISING	119-120
EP EXPOSITORES	---
LR LOCALIZACIÓN REFERENCIAS	123-124



 Ferramentas para tensor correia Alfa Romeo  
 Herramientas para tensor de correa Alfa Romeo

**ALFA ROMEO**





	<p><b>PSA:</b> 1.4L, 1.5L, 1.6L, 2.0L, 2.2L (diesel) <b>VAG:</b> 1.8L, 2.0L (gasolina) / 1.9L, 2.0L (diesel) <b>FCA:</b> 0.9L TwinAir (gasolina)</p>
	<p><b>PSA 1.4L, 1.5L, 1.6L, 2.0L, 2.2L (diesel)</b> Citroën, DS, Fiat, Ford, Mazda, Mini, Mitsubishi, Opel, Peugeot, Suzuki, Toyota, Vauxhall, Volvo (DV4, DV5, DV6, DW10, DW12)</p> <p><b>VAG 1.8L, 2.0L gasolina</b> <b>VW:</b> Eos, Golf, Jetta, Passat, Polo, Scirocco, Touran; <b>AUDI:</b> A1, A3, TT; <b>SKODA:</b> Octavia; <b>SEAT:</b> Altea, Leon, Toledo</p> <p><b>VAG 1.9L, 2.0L diesel</b> <b>VW:</b> Caddy, Eos, Golf Plus, Jetta, Multivan T5, Passat, Sharan, Tiguan, Touran, Transporter T5; <b>AUDI:</b> A3; <b>SKODA:</b> Octavia, Superb; <b>SEAT:</b> Alhambra, Altea, Iblza, Leon, Toledo</p> <p><b>FCA 0.9L TwinAir (gasolina)</b> <b>Fiat:</b> 500, 500L, Panda, Punto; <b>Alfa Romeo:</b> MiTo; <b>Lancia:</b> Ypsilon</p>

REF 1749	 800gr	 50x
-------------	--	--

 Ferramentas para tensor correia Audi  
 Herramientas para tensor de correa Audi

**AUDI**



	<p><b>PSA:</b> 1.4L, 1.5L, 1.6L, 2.0L, 2.2L (diesel) <b>VAG:</b> 1.8L, 2.0L (gasolina) / 1.9L, 2.0L (diesel) <b>FCA:</b> 0.9L TwinAir (gasolina)</p>
	<p><b>PSA 1.4L, 1.5L, 1.6L, 2.0L, 2.2L (diesel)</b> Citroën, DS, Fiat, Ford, Mazda, Mini, Mitsubishi, Opel, Peugeot, Suzuki, Toyota, Vauxhall, Volvo (DV4, DV5, DV6, DW10, DW12)</p> <p><b>VAG 1.8L, 2.0L gasolina</b> <b>VW:</b> Eos, Golf, Jetta, Passat, Polo, Scirocco, Touran; <b>AUDI:</b> A1, A3, TT; <b>SKODA:</b> Octavia; <b>SEAT:</b> Altea, Leon, Toledo</p> <p><b>VAG 1.9L, 2.0L diesel</b> <b>VW:</b> Caddy, Eos, Golf Plus, Jetta, Multivan T5, Passat, Sharan, Tiguan, Touran, Transporter T5; <b>AUDI:</b> A3; <b>SKODA:</b> Octavia, Superb; <b>SEAT:</b> Alhambra, Altea, Iblza, Leon, Toledo</p> <p><b>FCA 0.9L TwinAir (gasolina)</b> <b>Fiat:</b> 500, 500L, Panda, Punto; <b>Alfa Romeo:</b> MiTo; <b>Lancia:</b> Ypsilon</p>

REF 1749	 800gr	 50x
-------------	--	--



Kit tensor da correia auxiliar Citroën  
 Kit tensor de la correa auxiliar Citroën

**CITROËN**

	1.4L / 1.6L Hdi 8V / 16V 1.4L / 1.5L / 1.6L TDCi / ECOnetic 8V / 16V 1.4L / 1.6L TDCi 8V / 16V 1.6L 16V 1.4L DiD 8V 1.6L D4 16V
	<b>Citroën:</b> C1, C2, C3 III, C3 Pluriel, C4 Picasso <b>Ford:</b> B-Max, C-Max, EcoSport, Fiesta, Focus, Focus C-Max, Fusion, Galaxy, Grand C-Max, Mondeo, S-Max, Tourneo Connect / Courier, Transit Connect / Courier <b>Mazda:</b> 2 (DE/DH), 3 (BK/BL) <b>Mini:</b> Mini Clubman / Cooper / One (R55/R56) <b>Peugeot:</b> 1007, 107, 206 CC / SW, 307 SW, 508 <b>Toyota:</b> Aygo <b>Volvo:</b> C30, S40, S80, V50, V70

REF



680gr



10x

1747



Ferramentas para tensor correia Citroën  
 Herramientas para tensor de correa Citroën



	<b>PSA:</b> 1.4L, 1.5L, 1.6L, 2.0L, 2.2L (diesel) <b>VAG:</b> 1.8L, 2.0L (gasolina) / 1.9L, 2.0L (diesel) <b>FCA:</b> 0.9L TwinAir (gasolina)
	<b>PSA 1.4L, 1.5L, 1.6L, 2.0L, 2.2L (diesel)</b> Citroën, DS, Fiat, Ford, Mazda, Mini, Mitsubishi, Opel, Peugeot, Suzuki, Toyota, Vauxhall, Volvo (DV4, DV5, DV6, DW10, DW12) <b>VAG 1.8L, 2.0L gasolina</b> <b>VW:</b> Eos, Golf, Jetta, Passat, Polo, Scirocco, Touran; <b>AUDI:</b> A1, A3, TT; <b>SKODA:</b> Octavia; <b>SEAT:</b> Altea, Leon, Toledo <b>VAG 1.9L, 2.0L diesel</b> <b>VW:</b> Caddy, Eos, Golf Plus, Jetta, Multivan T5, Passat, Sharan, Tiguan, Touran, Transporter T5; <b>AUDI:</b> A3; <b>SKODA:</b> Octavia, Superb; <b>SEAT:</b> Alhambra, Altea, Ibiza, Leon, Toledo <b>FCA 0.9L TwinAir (gasolina)</b> <b>Fiat:</b> 500, 500L, Panda, Punto; <b>Alfa Romeo:</b> MiTo; <b>Lancia:</b> Ypsilon

REF





800gr







50x

1749

 Jogo bloqueio polia cambota 0.9/1.0/1.2/1.6 TCE Dacia  
 Herramienta bloqueio polea cigueñal 0.9/1.0/1.2/1.6 TCE Dacia

**DACIA**



	0.9L TCe; 1.0L TCe; 1.2L TCe; 1.6L TCe
	281.910, 281.910(H4B), 281.920, 281.920(H4D), H4B, H4B400, H4B401, H4B408, H4B 408, H4B410, H4B411, H4B451, H4B453, H4B 453, H4BT 400, H4BT 401, H4BT 408, H4BT 410, H4BT 451, H4D, H4D400, H4D 400, H4D450, H4D460, H4D470, H4M, H4M429, H4M438, H4M440, H4M729, H4M730, H4M738, H4M740, H4M748, H4M749, H5F, H5F400, H5F403, H5F404, H5F405, H5F408, H5F 408, H5F410, H5F 410, H5F412, H5FT 400, H5FT 402, H5FT 404, H5FT 405, H5FT 408, H5FT 410, H5FT 412
	<b>Dacia:</b> Dokker 2012-2019, Duster 2013-2018, Lodgy 2012-2018 <b>Renault:</b> Captur 2013-2019, Clio Iv 2012-2019, Kadjar 2015-2018, Kangooii 2013-On, Meganeiii 2012-2017, Meganeiv 2016-2020, Scenic/Grand Sceniciii 2012-2017, Scenic/Grand Sceniciv 2016-2018, Twingoiii 2014-On <b>Smart:</b> Fortwo 2014-2019, Forfour 2014-2019
	MOT.2054, MOT.2006, 281 589004000

REF



1722



600gr





30x

 Ferramentas para tensor correia DS  
 Herramientas para tensor de correa DS

**DS**



	<b>PSA:</b> 1.4L, 1.5L, 1.6L, 2.0L, 2.2L (diesel) <b>VAG:</b> 1.8L, 2.0L (gasolina) / 1.9L, 2.0L (diesel) <b>FCA:</b> 0.9L TwinAir (gasolina)
	<b>PSA 1.4L, 1.5L, 1.6L, 2.0L, 2.2L (diesel)</b> Citroën, DS, Fiat, Ford, Mazda, Mini, Mitsubishi, Opel, Peugeot, Suzuki, Toyota, Vauxhall, Volvo (DV4, DV5, DV6, DW10, DW12) <b>VAG 1.8L, 2.0L gasolina</b> <b>VW:</b> Eos, Golf, Jetta, Passat, Polo, Scirocco, Touran; <b>AUDI:</b> A1, A3, TT; <b>SKODA:</b> Octavia; <b>SEAT:</b> Altea, Leon, Toledo <b>VAG 1.9L, 2.0L diesel</b> <b>VW:</b> Caddy, Eos, Golf Plus, Jetta, Multivan T5, Passat, Sharan, Tiguan, Touran, Transporter T5; <b>AUDI:</b> A3; <b>SKODA:</b> Octavia, Superb; <b>SEAT:</b> Alhambra, Altea, Iblza, Leon, Toledo <b>FCA 0.9L TwinAir (gasolina)</b> <b>Fiat:</b> 500, 500L, Panda, Punto; <b>Alfa Romeo:</b> MiTo; <b>Lancia:</b> Ypsilon

REF



1749





800gr



50x

 Ferramentas para tensor correia Fiat  
 Herramientas para tensor de correa Fiat

**FIAT**

	<b>PSA:</b> 1.4L, 1.5L, 1.6L, 2.0L, 2.2L (diesel) <b>VAG:</b> 1.8L, 2.0L (gasolina) / 1.9L, 2.0L (diesel) <b>FCA:</b> 0.9L TwinAir (gasolina)
	<b>PSA 1.4L, 1.5L, 1.6L, 2.0L, 2.2L (diesel)</b> Citroën, DS, Fiat, Ford, Mazda, Mini, Mitsubishi, Opel, Peugeot, Suzuki, Toyota, Vauxhall, Volvo (DV4, DV5, DV6, DW10, DW12)  <b>VAG 1.8L, 2.0L gasolina</b> <b>VW:</b> Eos, Golf, Jetta, Passat, Polo, Scirocco, Touran; <b>AUDI:</b> A1, A3, TT; <b>SKODA:</b> Octavia; <b>SEAT:</b> Altea, Leon, Toledo  <b>VAG 1.9L, 2.0L diesel</b> <b>VW:</b> Caddy, Eos, Golf Plus, Jetta, Multivan T5, Passat, Sharan, Tiguan, Touran, Transporter T5; <b>AUDI:</b> A3; <b>SKODA:</b> Octavia, Superb; <b>SEAT:</b> Alhambra, Altea, Iblza, Leon, Toledo  <b>FCA 0.9L TwinAir (gasolina)</b> <b>Fiat:</b> 500, 500L, Panda, Punto; <b>Alfa Romeo:</b> MiTo; <b>Lancia:</b> Ypsilon



REF







1749

800gr

50x

 Jogo bloqueio árvore cames 1.1 Ford gasolina  
 Bloques de ajuste del árbol de levas - Ford 1.1

**FORD**

	1.1L
	XPJA, XPJB, XPJC, XPJD, XYJA, XYJB, XYJC, XYJD, XYJE
	Fiesta( -2017)
	303-1605 (para utilização apenas no motor 1.1, não turbo) / (para uso exclusivo en el motor 1.1, no turbo)



REF







1715

300gr



50x

 Jogo sincronização Ford 1.1 Gasolina - correia húmida  
 Kit calado Ford 1.1 Gasolina - correia húmeda







	1.1L
	XPJA, XPJB, XPJC, XPJD, XYJA, XYJB, XYJC, XYJD, XYJE
	B-Max (2012 - 2018), C-Max (2013 - 2018), EcoSport (a partir de 2014), Fiesta (a partir de 2014), Focus (2013 - 2020), Mondeo (2015 - 2018) e Transit/Tourneo (a partir de 2014)
	303-1602, 303-1603, 303-1604, 303-1605, 303-732 e 303-1054

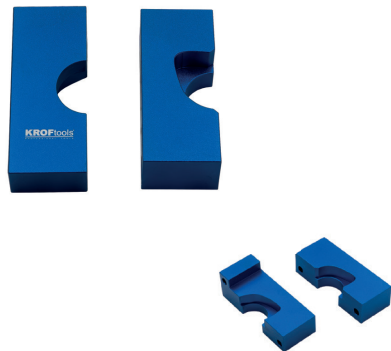

<b>REF</b>		
<b>1717</b>	<b>2kg</b>	<b>5x</b>

 Jogo bloqueio árvore cames 1.0 Gtdi Ford gasolina  
 Bloques de ajuste del árbol de levas - Ford 1.0 Gtdi





	1.0L GTDI
	M1CA, M1CB, M1DA, M1DD, M1JA, M1JC, M1JE, M1JH, M1JJ, M2DA, M2DB, M2DC, M2GA, M2GB, SFCA, SFCB, SFCC, SFCD, SFDB, SFJA, SFJB, SFJC, SFJD, XMJA, YYJB
	B-Max (2012 - 2018), C-Max (2013 - 2018), EcoSport (a partir de 2014), Fiesta (a partir de 2014), Focus (2013 - 2020), Mondeo (2015 - 2018) e Transit/Tourneo (a partir de 2014)
	303-1605/1 e 303-1605/2

<b>REF</b>		
<b>1720</b>	<b>300gr</b>	<b>50x</b>

-  Kit sincronização Ford 1.0 gtdi gasolina  
 Kit calado Ford 1.0 gtdi gasolina



	1.0L
	M1CA, M1CB, M1DA, M1DD, M1JA, M1JC, M1JE, M1JH, M1JJ, M2DA, M2DB, M2DC, M2GA, M2GB, SFCA, SFCB, SFCC, SFCD, SFDB, SFJA, SFJB, SFJC, SFJD, XMJA, YYJB
	B-Max (12-17), C-Max (12-17), EcoSport (13-17), Fiesta (13-17), Focus (12-17), Grand C-MAX (12-17), Grand Tourneo Connect (13-17), Mondeo (15-17), Tourneo Connect (13-17), Transit Connect (13-17), Transit Courier (14-17)
<b>OEM</b>	303-1602, 303-1604, 303-1605/1 e 303-1605/2 303-1054, 303-732, 303-1603

REF



1721



2,2kg



5x

-  Kit pinos de alinhamento subestrutura Ford  
 Conjunto de pinas de alineación del subchasis para Ford



	Ford C-Max, Cougar, Escort, Fiesta, Focus, Fusion, Galaxy, Kuga, Mondeo, Orion, Puma, S-Max, Tourneo Connect, Transit, Transit Connect e Transit Custom
<b>OEM</b>	205-316-A

REF



1736





700gr



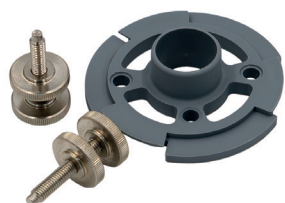

24x

-  Ferramenta de fixação da roda dentada da bomba de injeção p/ Ford 2.2 e 3.2 TDCI  
 Herramienta de fijación del piñón de la bomba de inyección para Ford 2.2 y 3.2 TDCI



	2.2L, 3.2L TDCI
	Ford Transit 2.2 Duratorq (2006-), Ford Transit 3.2 Duratorq (2006-), Ford Ranger 2.2 Duratorq (2011-)
<b>OEM</b>	303-1317

 **Descrição:**  
 Permite a remoção da bomba de injeção sem alterar a sincronização do motor.

 **Descripción:**  
 Permite desmontar la bomba de inyección sin alterar la sincronización del motor.

REF

1738







255gr

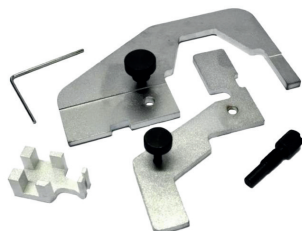

20x



 Jogo sincronização Ford ecoboost 2.0 e 2.3  
 Kit calado Ford ecoboost 2.0 y 2.3







	2.0L, 2.3L EcoBoost
	<b>2.0L:</b> MGDA, R9CB, R9CD, R9CF, R9CH, R9CI, R9DA, R9DB, R9DC, R9DD, TNBA, TNBB, TNCC, TNCD, TNCF, TNWA, TNWB, TPBA, TPWA, XQDA <b>2.3L:</b> YVDA
	Ford Focus (2011 - 2018), Galaxy (2010 - 2018), Mondeo (2010 - 2018), S-MAX (2010 - 2018)
	303-1504, 303-1565, 303-1521, 303-748

 **NOTA:** Foto figurativa  
**NOTA:** Foto ilustrativa



REF		
1741	1,8kg	5x

 Kit de regulação árvore cames Ford 1.0 Gasolina wetbelt sem turbo  
 Kit de reglaje del árbol de levas para Ford 1.0 Gasolina con correa húmeda sin turbo





	1.0L
	P4JA, P4JB, P4JC, P4JD, XMJA, XMJB, XMJC, XMJD
	Ford Fiesta (2013 - 2017)
	303-1605



REF		
1745	1,3kg	5x

 Kit tensor da correia auxiliar Ford  
 Kit tensor de la correia auxiliar Ford





	1.4L / 1.6L Hdi 8V / 16V 1.4L / 1.5L / 1.6L TDCi / EConetic 8V / 16V 1.4L / 1.6L TDCi 8V / 16V 1.6L 16V 1.4L DiD 8V 1.6L D4 16V
	<b>Citroën:</b> C1, C2, C3 III, C3 Pluriel, C4 Picasso <b>Ford:</b> B-Max, C-Max, EcoSport, Fiesta, Focus, Focus C-Max, Fusion, Galaxy, Grand C-Max, Mondeo, S-Max, Tourneo Connect / Courier, Transit Connect / Courier <b>Peugeot:</b> 1007, 107, 206 CC / SW, 307 SW, 508 <b>Mazda:</b> 2 (DE/DH), 3 (BK/BL) <b>Mini:</b> Mini Clubman / Cooper / One (R55 / R56) <b>Peugeot:</b> 1007, 107, 206 CC / SW, 307 SW, 508 <b>Toyota:</b> Aygo <b>Volvo:</b> C30, S40, S80, V50, V70



REF		
1747	680gr	10x

 Ferramentas para tensor correia Ford  
 Herramientas para tensor de correia Ford







	<b>PSA:</b> 1.4L, 1.5L, 1.6L, 2.0L, 2.2L (diesel) <b>VAG:</b> 1.8L, 2.0L (gasolina) / 1.9L, 2.0L (diesel) <b>FCA:</b> 0.9L TwinAir (gasolina)
	<b>PSA 1.4L, 1.5L, 1.6L, 2.0L, 2.2L (diesel)</b> Citroën, DS, Fiat, Ford, Mazda, Mini, Mitsubishi, Opel, Peugeot, Suzuki, Toyota, Vauxhall, Volvo (DV4, DV5, DV6, DW10, DW12)  <b>VAG 1.8L, 2.0L gasolina</b> <b>VW:</b> Eos, Golf, Jetta, Passat, Polo, Scirocco, Touran; <b>AUDI:</b> A1, A3, TT; <b>SKODA:</b> Octavia; <b>SEAT:</b> Altea, Leon, Toledo  <b>VAG 1.9L, 2.0L diesel</b> <b>VW:</b> Caddy, Eos, Golf Plus, Jetta, Multivan T5, Passat, Sharan, Tiguan, Touran, Transporter T5; <b>AUDI:</b> A3; <b>SKODA:</b> Octavia, Superb; <b>SEAT:</b> Alhambra, Altea, Ibiza, Leon, Toledo  <b>FCA 0.9L TwinAir (gasolina)</b> <b>Fiat:</b> 500, 500L, Panda, Punto; <b>Alfa Romeo:</b> MiTo; <b>Lancia:</b> Ypsilon

REF		
1749	800gr	50x



 Kit sincronização Ford gasolina 1.2  
 Kit calado Ford 1.2 gasolina



 **NOTA:** Foto figurativa  
**NOTA:** Foto ilustrativa



	1.2L
	B1KE, ENAP, ENBI
	Ford Ka+ (2018 - 2020), Ford Ka+ Active (2018 - 2020)
	303-1643, OEM 303-1639 & 303-1645.B

REF		
1750	1,5kg	5x



 Ferramenta compressão tensor correia Hyundai Híbrido  
 Herramienta de compresión tensor de correa Hyundai Hybrid

**HYUNDAI**





	1.6 GDi Hybrid, 1.6 GDi Plug-in, 2.0lt GDi Plug-in
	<b>Hyundai:</b> Ioniq 1.6 GDi Hybrid (2016 - 2022), Kona 1.6 GDi Hybrid (2019 - 2022) <b>Kia:</b> Niro 1.6 GDi Plug-in (2017 - 2022), Optima 2.0lt GDi Plug-in (2016 to 2020), XCeed 1.6 GDi plug-in (2020 - 2022)
	09244-G21000, 9252-2E100



REF		
1735	800gr	20x

 Kit de bloqueio volante motor Hyundai HEV & PHEV  
 Kit de bloqueo del volante de motor para Hyundai HEV Y PHEV





	<b>HEV &amp; PHEV:</b> Hyundai Tucson, Sante Fe. KIA Sportage, Sorento.
	09231 3D200

REF		
8765	500gr	20x

 Ferramenta compressão tensor correia Kia Híbrido  
 Herramienta de compresión tensor de correa Kia Hybrid

**KIA**

	1.6L GDi Hybrid, 1.6 GDi Plug-in, 2.0lt GDi Plug-in
	<b>Hyundai:</b> Ioniq 1.6 GDi Hybrid (2016 - 2022), Kona 1.6 GDi Hybrid (2019 - 2022) <b>Kia:</b> Niro 1.6 GDi Plug-in (2017 - 2022), Optima 2.0lt GDi Plug-in (2016 to 2020), Xceed 1.6 GDi plug-in (2020 - 2022)
	09244-G21000, 9252-2E100



REF





1735

800gr

20x

 Kit de bloqueio volante motor Kia HEV & PHEV  
 Kit de bloqueo del volante de motor para Kia HEV Y PHEV



	<b>HEV &amp; PHEV:</b> Hyundai Tucson, Sante Fe. KIA Sportage, Sorento.
	09231 3D200



REF





8765

500gr

20x

 Ferramentas para tensor correia Lancia  
 Herramientas para tensor de correa Lancia

**LANCIA**

	<b>PSA:</b> 1.4L, 1.5L, 1.6L, 2.0L, 2.2L (diesel) <b>VAG:</b> 1.8L, 2.0L (gasolina) / 1.9L, 2.0L (diesel) <b>FCA:</b> 0.9L TwinAir (gasolina)
	<b>PSA 1.4L, 1.5L, 1.6L, 2.0L, 2.2L (diesel)</b> Citroën, DS, Fiat, Ford, Mazda, Mini, Mitsubishi, Opel, Peugeot, Suzuki, Toyota, Vauxhall, Volvo (DV4, DV5, DV6, DW10, DW12)  <b>VAG 1.8L, 2.0L gasolina</b> <b>VW:</b> Eos, Golf, Jetta, Passat, Polo, Scirocco, Touran; <b>AUDI:</b> A1, A3, TT; <b>SKODA:</b> Octavia; <b>SEAT:</b> Altea, Leon, Toledo  <b>VAG 1.9L, 2.0L diesel</b> <b>VW:</b> Caddy, Eos, Golf Plus, Jetta, Multivan T5, Passat, Sharan, Tiguan, Touran, Transporter T5; <b>AUDI:</b> A3; <b>SKODA:</b> Octavia, Superb; <b>SEAT:</b> Alhambra, Altea, Ibiza, Leon, Toledo  <b>FCA 0.9L TwinAir (gasolina)</b> <b>Fiat:</b> 500, 500L, Panda, Punto; <b>Alfa Romeo:</b> MiTo; <b>Lancia:</b> Ypsilon



REF



1749





800gr

50x

 Jogo sincronização Land rover TDV8 4.4L  
 Kit calado Land rover TDV8 4.4L

**LAND ROVER**



	4.4L
	448DT
	Range Rover (2010 - ) e Range Rover Sport (2014 - )
	JLR 303-1620, 303-1568, 303-1243 e 303-1571

REF



1739



4kg





2x

 Kit tensor da correia auxiliar Mazda  
 Kit tensor de la correia auxiliar Mazda

**MAZDA**



	1.4L / 1.6L Hdi 8V / 16V 1.4L / 1.5L / 1.6L TDCi / ECONetic 8V / 16V 1.4L / 1.6L TDCi 8V / 16V 1.6L 16V 1.4L DiD 8V 1.6L D4 16V
	<b>Citroën:</b> C1, C2, C3 III, C3 Pluriel, C4 Picasso <b>Ford:</b> B-Max, C-Max, EcoSport, Fiesta, Focus, Focus C-Max, Fusion, Galaxy, Grand C-Max, Mondeo, S-Max, Tourneo Connect / Courier, Transit Connect / Courier <b>Peugeot:</b> 1007, 107, 206 CC / SW, 307 SW, 508 <b>Mazda:</b> 2 (DE/DH), 3 (BK/BL) <b>Mini:</b> Mini Clubman / Cooper / One (R55 / R56) <b>Peugeot:</b> 1007, 107, 206 CC / SW, 307 SW, 508 <b>Toyota:</b> Aygo <b>Volvo:</b> C30, S40, S80, V50, V70

REF



1747





680gr





10x

-  Ferramentas para tensor correia Mazda  
 Herramientas para tensor de correa Mazda





	<b>PSA:</b> 1.4L, 1.5L, 1.6L, 2.0L, 2.2L (diesel) <b>VAG:</b> 1.8L, 2.0L (gasolina) / 1.9L, 2.0L (diesel) <b>FCA:</b> 0.9L TwinAir (gasolina)
	<b>PSA 1.4L, 1.5L, 1.6L, 2.0L, 2.2L (diesel)</b> Citroën, DS, Fiat, Ford, Mazda, Mini, Mitsubishi, Opel, Peugeot, Suzuki, Toyota, Vauxhall, Volvo (DV4, DV5, DV6, DW10, DW12)  <b>VAG 1.8L, 2.0L gasolina</b> <b>VW:</b> Eos, Golf, Jetta, Passat, Polo, Scirocco, Touran; <b>AUDI:</b> A1, A3, TT; <b>SKODA:</b> Octavia; <b>SEAT:</b> Altea, Leon, Toledo  <b>VAG 1.9L, 2.0L diesel</b> <b>VW:</b> Caddy, Eos, Golf Plus, Jetta, Multivan T5, Passat, Sharan, Tiguan, Touran, Transporter T5; <b>AUDI:</b> A3; <b>SKODA:</b> Octavia, Superb; <b>SEAT:</b> Alhambra, Altea, Ibiza, Leon, Toledo  <b>FCA 0.9L TwinAir (gasolina)</b> <b>Fiat:</b> 500, 500L, Panda, Punto; <b>Alfa Romeo:</b> MiTo; <b>Lancia:</b> Ypsilon



REF		
1749	800gr	50x

-  Ferramenta de fixação da corrente de distribuição Mercedes  
 Herramienta de sujeción de la cadena de distribución Mercedes



**MERCEDES**

	M642
	642 589 01 40 00 / 642589014000

REF		
1737	78gr	100x



 Ferramenta de remoção bomba diesel Mercedes 1.6 2.0L HP  
 Herramienta para extracción de bomba diésel Mercedes 1.6 2.0L HP







	1.6, 2.0L
	A Class (2019), B Class (2019), C Class (2018), CLA (2019), CLS (2018), E Class (2016), GLB (2019), GLC Coupe (2019), GLE (2019), V Class (2019), Vito (2019).

⚠ **NOTA:** Foto figurativa  
 ⚠ **NOTA:** Foto ilustrativa

REF		
1742	260gr	48x



 Kit sincronização árvore cames Mercedes-benz  
 Kit de reglaje del árbol de levas para Mercedes-benz





	1.5L, 2.0L, 3.0L, 4.0L
	256.930 3.0L, 254.915 1.5L, 254.920 2.0L, 176.980 4.0L, 177.980 4.0L, 178.980 4
	Mercedes-Benz AMG GT (2018-), CLS (2018-), E-Class (2018-), GLE (2019-), GLS (2019-), S-Class (2017-)
	256 589 00 23 00 177 589 01 09 00

⚠ **NOTA:** Foto figurativa  
 ⚠ **NOTA:** Foto ilustrativa

REF		
1751	867gr	20x

-  Chave para válvula regulação árvore cames M651 Mercedes  
 Herramienta de sujeción de la cadena de distribución Mercedes



	M651.9, M651.91, M651.92, M651.93, M651.94, M651.95, M651.96
	Mercedes-Benz: Classe A (2012–2018), Classe B (2011–2018), Classe C (2011–2018), CLA (2013–2019), CLS (2012–2016), Classe E (2010–2016), GLA (desde 2013), GLC (2015–2019), GLE (2012–2015), Classe S (2014–2017), Sprinter (desde 2014) e Vito (desde 2012)
	651 589 000 900

REF



6127







229gr



48x

-  Kit de distribuição para motores MG 1.5 a gasolina  
 Kit de distribución para motores MG 1.5 a gasolina

**MG**

	1.5
	15S4C, 15S4U
	MG3 (2013-2022) ZS (2017-2022)
	TEN00004 TEN00002

 **NOTA:** Foto figurativa  
**NOTA:** Foto ilustrativa

REF



1746



1,02kg





5x

 Kit tensor da correia auxiliar Mini  
 Kit tensor de la correia auxiliar Mini

**MINI**



	<p>1.4L / 1.6L Hdi 8V / 16V 1.4L / 1.5L / 1.6L TDCi / ECONetic 8V / 16V 1.4L / 1.6L TDCi 8V / 16V 1.6L 16V 1.4L DiD 8V 1.6L D4 16V</p>
	<p><b>Citroën:</b> C1, C2, C3 III, C3 Pluriel, C4 Picasso <b>Ford:</b> B-Max, C-Max, EcoSport, Fiesta, Focus, Focus C-Max, Fusion, Galaxy, Grand C-Max, Mondeo, S-Max, Tourneo Connect / Courier, Transit Connect / Courier <b>Peugeot:</b> 1007, 107, 206 CC / SW, 307 SW, 508 <b>Mazda:</b> 2 (DE/DH), 3 (BK/BL) <b>Mini:</b> Mini Clubman / Cooper / One (R55/R56) <b>Peugeot:</b> 1007, 107, 206 CC / SW, 307 SW, 508 <b>Toyota:</b> Aygo <b>Volvo:</b> C30, S40, S80, V50, V70</p>

REF



1747





680gr



10x

 Ferramentas para tensor correia Mini  
 Herramientas para tensor de correia Mini



	<p><b>PSA:</b> 1.4L, 1.5L, 1.6L, 2.0L, 2.2L (diesel) <b>VAG:</b> 1.8L, 2.0L (gasolina) / 1.9L, 2.0L (diesel) <b>FCA:</b> 0.9L TwinAir (gasolina)</p>
	<p><b>PSA 1.4L, 1.5L, 1.6L, 2.0L, 2.2L (diesel)</b> Citroën, DS, Fiat, Ford, Mazda, Mini, Mitsubishi, Opel, Peugeot, Suzuki, Toyota, Vauxhall, Volvo (DV4, DV5, DV6, DW10, DW12)</p> <p><b>VAG 1.8L, 2.0L gasolina</b> <b>VW:</b> Eos, Golf, Jetta, Passat, Polo, Scirocco, Touran; <b>AUDI:</b> A1, A3, TT; <b>SKODA:</b> Octavia; <b>SEAT:</b> Altea, Leon, Toledo</p> <p><b>VAG 1.9L, 2.0L diesel</b> <b>VW:</b> Caddy, Eos, Golf Plus, Jetta, Multivan T5, Passat, Sharan, Tiguan, Touran, Transporter T5; <b>AUDI:</b> A3; <b>SKODA:</b> Octavia, Superb; <b>SEAT:</b> Alhambra, Altea, Iblza, Leon, Toledo</p> <p><b>FCA 0.9L TwinAir (gasolina)</b> <b>Fiat:</b> 500, 500L, Panda, Punto; <b>Alfa Romeo:</b> MiTo; <b>Lancia:</b> Ypsilon</p>

REF



1749





800gr



50x

 Ferramentas para tensor correia Mitsubishi  
 Herramientas para tensor de correa Mitsubishi

**MITSUBISHI**

	<b>PSA:</b> 1.4L, 1.5L, 1.6L, 2.0L, 2.2L (diesel) <b>VAG:</b> 1.8L, 2.0L (gasolina) / 1.9L, 2.0L (diesel) <b>FCA:</b> 0.9L TwinAir (gasolina)
	<b>PSA 1.4L, 1.5L, 1.6L, 2.0L, 2.2L (diesel)</b> Citroën, DS, Fiat, Ford, Mazda, Mini, Mitsubishi, Opel, Peugeot, Suzuki, Toyota, Vauxhall, Volvo (DV4, DV5, DV6, DW10, DW12)  <b>VAG 1.8L, 2.0L gasolina</b> <b>VW:</b> Eos, Golf, Jetta, Passat, Polo, Scirocco, Touran; <b>AUDI:</b> A1, A3, TT; <b>SKODA:</b> Octavia; <b>SEAT:</b> Altea, Leon, Toledo  <b>VAG 1.9L, 2.0L diesel</b> <b>VW:</b> Caddy, Eos, Golf Plus, Jetta, Multivan T5, Passat, Sharan, Tiguan, Touran, Transporter T5; <b>AUDI:</b> A3; <b>SKODA:</b> Octavia, Superb; <b>SEAT:</b> Alhambra, Altea, Ibiza, Leon, Toledo  <b>FCA 0.9L TwinAir (gasolina)</b> <b>Fiat:</b> 500, 500L, Panda, Punto; <b>Alfa Romeo:</b> MiTo; <b>Lancia:</b> Ypsilon

REF



1749

800gr

50x

 Jogo sincronização Opel Astra K 1.2 2019  
 Kit calado Opel Astra K 1.2 2019

**OPEL/VAUXHALL**

	1.2
	F12SHL, F12SHT, F12SHR
	Opel Astra K



REF





1740

4,5kg



2x

 Ferramentas para tensor correia Opel  
 Herramientas para tensor de correa Opel





	<p><b>PSA:</b> 1.4L, 1.5L, 1.6L, 2.0L, 2.2L (diesel) <b>VAG:</b> 1.8L, 2.0L (gasolina) / 1.9L, 2.0L (diesel) <b>FCA:</b> 0.9L TwinAir (gasolina)</p>
	<p><b>PSA 1.4L, 1.5L, 1.6L, 2.0L, 2.2L (diesel)</b> Citroën, DS, Fiat, Ford, Mazda, Mini, Mitsubishi, Opel, Peugeot, Suzuki, Toyota, Vauxhall, Volvo (DV4, DV5, DV6, DW10, DW12)</p> <p><b>VAG 1.8L, 2.0L gasolina</b> <b>VW:</b> Eos, Golf, Jetta, Passat, Polo, Scirocco, Touran; <b>AUDI:</b> A1, A3, TT; <b>SKODA:</b> Octavia; <b>SEAT:</b> Altea, Leon, Toledo</p> <p><b>VAG 1.9L, 2.0L diesel</b> <b>VW:</b> Caddy, Eos, Golf Plus, Jetta, Multivan T5, Passat, Sharan, Tiguan, Touran, Transporter T5; <b>AUDI:</b> A3; <b>SKODA:</b> Octavia, Superb; <b>SEAT:</b> Alhambra, Altea, Iblza, Leon, Toledo</p> <p><b>FCA 0.9L TwinAir (gasolina)</b> <b>Fiat:</b> 500, 500L, Panda, Punto; <b>Alfa Romeo:</b> MiTo; <b>Lancia:</b> Ypsilon</p>

<b>REF</b>		
1749	800gr	50x



 Kit tensor da correia auxiliar Peugeot  
 Kit tensor de la correa auxiliar Peugeot

**PEUGEOT**





	<p>1.4L / 1.6L Hdi 8V / 16V 1.4L / 1.5L / 1.6L TDCi / ECONetic 8V / 16V 1.4L / 1.6L TDCi 8V / 16V 1.6L 16V 1.4L DiD 8V 1.6L D4 16V</p>
	<p><b>Citroën:</b> C1, C2, C3 III, C3 Pluriel, C4 Picasso <b>Ford:</b> B-Max, C-Max, EcoSport, Fiesta, Focus, Focus C-Max, Fusion, Galaxy, Grand C-Max, Mondeo, S-Max, Tourneo Connect / Courier, Transit Connect / Courier <b>Peugeot:</b> 1007, 107, 206 CC / SW, 307 SW, 508 <b>Mazda:</b> 2 (DE/DH), 3 (BK/BL) <b>Mini:</b> Mini Clubman / Cooper / One (R55/R56) <b>Peugeot:</b> 1007, 107, 206 CC / SW, 307 SW, 508 <b>Toyota:</b> Aygo <b>Volvo:</b> C30, S40, S80, V50, V70</p>



<b>REF</b>		
1747	680gr	10x

 Ferramentas para tensor correia Peugeot  
 Herramientas para tensor de correa Peugeot







	<b>PSA:</b> 1.4L, 1.5L, 1.6L, 2.0L, 2.2L (diesel) <b>VAG:</b> 1.8L, 2.0L (gasolina) / 1.9L, 2.0L (diesel) <b>FCA:</b> 0.9L TwinAir (gasolina)
	<b>PSA 1.4L, 1.5L, 1.6L, 2.0L, 2.2L (diesel)</b> Citroën, DS, Fiat, Ford, Mazda, Mini, Mitsubishi, Opel, Peugeot, Suzuki, Toyota, Vauxhall, Volvo (DV4, DV5, DV6, DW10, DW12)  <b>VAG 1.8L, 2.0L gasolina</b> <b>VW:</b> Eos, Golf, Jetta, Passat, Polo, Scirocco, Touran; <b>AUDI:</b> A1, A3, TT; <b>SKODA:</b> Octavia; <b>SEAT:</b> Altea, Leon, Toledo  <b>VAG 1.9L, 2.0L diesel</b> <b>VW:</b> Caddy, Eos, Golf Plus, Jetta, Multivan T5, Passat, Sharan, Tiguan, Touran, Transporter T5; <b>AUDI:</b> A3; <b>SKODA:</b> Octavia, Superb; <b>SEAT:</b> Alhambra, Altea, Ibiza, Leon, Toledo  <b>FCA 0.9L TwinAir (gasolina)</b> <b>Fiat:</b> 500, 500L, Panda, Punto; <b>Alfa Romeo:</b> MiTo; <b>Lancia:</b> Ypsilon

REF		
1749	800gr	50x

 Jogo bloqueio polia cambota 0.9/1.0/1.2/1.6 TCE Renault  
 Herramienta bloqueo polea cigueñal 0.9/1.0/1.2/1.6 TCE Renault

**RENAULT**

	0.9 TCE; 1.0 TCE; 1.2 TCE; 1.6TCE
	281.910, 281.910(H4B), 281.920, 281.920(H4D), H4B, H4B400, H4B401, H4B408, H4B 408, H4B410, H4B411, H4B451, H4B453, H4B 453, H4BT 400, H4BT 401, H4BT 408, H4BT 410, H4BT 451, H4D, H4D400, H4D 400, H4D450, H4D460, H4D470, H4M, H4M429, H4M438, H4M440, H4M729, H4M730, H4M738, H4M740, H4M748, H4M749, H5F, H5F400, H5F403, H5F404, H5F405, H5F408, H5F 408, H5F410, H5F 410, H5F412, H5FT 400, H5FT 402, H5FT 404, H5FT 405, H5FT 408, H5FT 410, H5FT 412
	<b>Dacia:</b> Dokker 2012-2019, Duster 2013-2018, Lodgy 2012-2018 <b>Renault:</b> Captur 2013-2019, Clio Iv 2012-2019, Kadjar 2015-2018, Kangooii 2013-On, Meganeiii 2012-2017, Meganeiv 2016-2020, Scenic/Grand Sceniciii 2012-2017, Scenic/Grand Sceniciv 2016-2018, Twingooiii 2014-On <b>Smart:</b> Fortwo 2014-2019, Forfour 2014-2019
	MOT.2054, MOT.2006, 281 589004000

REF		
1722	600gr	30x

Ferramentas para tensor correia Seat  
Herramientas para tensor de correa Seat

**SEAT**



	<p><b>PSA:</b> 1.4L, 1.5L, 1.6L, 2.0L, 2.2L (diesel)  <b>VAG:</b> 1.8L, 2.0L (gasolina) / 1.9L, 2.0L (diesel)  <b>FCA:</b> 0.9L TwinAir (gasolina)</p>
	<p><b>PSA 1.4L, 1.5L, 1.6L, 2.0L, 2.2L (diesel)</b>                  Citroën, DS, Fiat, Ford, Mazda, Mini, Mitsubishi, Opel, Peugeot, Suzuki, Toyota, Vauxhall, Volvo (DV4, DV5, DV6, DW10, DW12)</p> <p><b>VAG 1.8L, 2.0L gasolina</b>  <b>VW:</b> Eos, Golf, Jetta, Passat, Polo, Scirocco, Touran; <b>AUDI:</b> A1, A3, TT; <b>SKODA:</b> Octavia;  <b>SEAT:</b> Altea, Leon, Toledo</p> <p><b>VAG 1.9L, 2.0L diesel</b>  <b>VW:</b> Caddy, Eos, Golf Plus, Jetta, Multivan T5, Passat, Sharan, Tiguan, Touran, Transporter T5; <b>AUDI:</b> A3; <b>SKODA:</b> Octavia, Superb; <b>SEAT:</b> Alhambra, Altea, Iblza, Leon, Toledo</p> <p><b>FCA 0.9L TwinAir (gasolina)</b>  <b>Fiat:</b> 500, 500L, Panda, Punto; <b>Alfa Romeo:</b> MiTo; <b>Lancia:</b> Ypsilon</p>

REF



1749

800gr

50x

Ferramentas para tensor correia Škoda  
Herramientas para tensor de correa Škoda

**ŠKODA**



	<p><b>PSA:</b> 1.4L, 1.5L, 1.6L, 2.0L, 2.2L (diesel)  <b>VAG:</b> 1.8L, 2.0L (gasolina) / 1.9L, 2.0L (diesel)  <b>FCA:</b> 0.9L TwinAir (gasolina)</p>
	<p><b>PSA 1.4L, 1.5L, 1.6L, 2.0L, 2.2L (diesel)</b>                  Citroën, DS, Fiat, Ford, Mazda, Mini, Mitsubishi, Opel, Peugeot, Suzuki, Toyota, Vauxhall, Volvo (DV4, DV5, DV6, DW10, DW12)</p> <p><b>VAG 1.8L, 2.0L gasolina</b>  <b>VW:</b> Eos, Golf, Jetta, Passat, Polo, Scirocco, Touran; <b>AUDI:</b> A1, A3, TT; <b>SKODA:</b> Octavia;  <b>SEAT:</b> Altea, Leon, Toledo</p> <p><b>VAG 1.9L, 2.0L diesel</b>  <b>VW:</b> Caddy, Eos, Golf Plus, Jetta, Multivan T5, Passat, Sharan, Tiguan, Touran, Transporter T5; <b>AUDI:</b> A3; <b>SKODA:</b> Octavia, Superb; <b>SEAT:</b> Alhambra, Altea, Iblza, Leon, Toledo</p> <p><b>FCA 0.9L TwinAir (gasolina)</b>  <b>Fiat:</b> 500, 500L, Panda, Punto; <b>Alfa Romeo:</b> MiTo; <b>Lancia:</b> Ypsilon</p>



REF







1749

800gr

50x

 Jogo bloqueio polia cambota 0.9/1.0/1.2/1.6 TCE Smart  
 Herramienta bloqueo polea cigueñal 0.9/1.0/1.2/1.6 TCE Smart

**SMART**

	0.9 TCe; 1.0 TCe; 1.2 TCe; 1.6TCe
	281.910, 281.910(H4B), 281.920, 281.920(H4D), H4B, H4B400, H4B401, H4B408, H4B 408, H4B410, H4B411, H4B451, H4B453, H4B 453, H4BT 400, H4BT 401, H4BT 408, H4BT 410, H4BT 451, H4D, H4D400, H4D 400, H4D450, H4D460, H4D470, H4M, H4M429, H4M438, H4M440, H4M729, H4M730, H4M738, H4M740, H4M748, H4M749, H5F, H5F400, H5F403, H5F404, H5F405, H5F408, H5F 408, H5F410, H5F 410, H5F412, H5FT 400, H5FT 402, H5FT 404, H5FT 405, H5FT 408, H5FT 410, H5FT 412
	<b>Dacia:</b> Dokker 2012-2019, Duster 2013-2018, Lodgy 2012-2018 <b>Renault:</b> Captur 2013-2019, Clio Iv 2012-2019, Kadjar 2015-2018, Kangooii 2013-On, Meganeiii 2012-2017, Meganeiv 2016-2020, Scenic/Grand Sceniciii 2012-2017, Scenic/Grand Sceniciv 2016-2018, Twingoiii 2014-On <b>Smart:</b> Fortwo 2014-2019, Forfour 2014-2019
	MOT.2054, MOT.2006, 281 589004000



REF





1722

600gr

30x

 Ferramentas para tensor correia Suzuki  
 Herramientas para tensor de correa Suzuki

**SUZUKI**

	<b>PSA:</b> 1.4L, 1.5L, 1.6L, 2.0L, 2.2L (diesel) <b>VAG:</b> 1.8L, 2.0L (gasolina) / 1.9L, 2.0L (diesel) <b>FCA:</b> 0.9L TwinAir (gasolina)
	<b>PSA 1.4L, 1.5L, 1.6L, 2.0L, 2.2L (diesel)</b> Citroën, DS, Fiat, Ford, Mazda, Mini, Mitsubishi, Opel, Peugeot, Suzuki, Toyota, Vauxhall, Volvo (DV4, DV5, DV6, DW10, DW12) <b>VAG 1.8L, 2.0L gasolina</b> <b>VW:</b> Eos, Golf, Jetta, Passat, Polo, Scirocco, Touran; <b>AUDI:</b> A1, A3, TT; <b>SKODA:</b> Octavia; <b>SEAT:</b> Altea, Leon, Toledo <b>VAG 1.9L, 2.0L diesel</b> <b>VW:</b> Caddy, Eos, Golf Plus, Jetta, Multivan T5, Passat, Sharan, Tiguan, Touran, Transporter T5; <b>AUDI:</b> A3; <b>SKODA:</b> Octavia, Superb; <b>SEAT:</b> Alhambra, Altea, Iblza, Leon, Toledo <b>FCA 0.9L TwinAir (gasolina)</b> <b>Fiat:</b> 500, 500L, Panda, Punto; <b>Alfa Romeo:</b> MiTo; <b>Lancia:</b> Ypsilon



REF



1749



800gr

50x

 Kit tensor da correia auxiliar Toyota  
 Kit tensor de la correia auxiliar Toyota

**TOYOTA**



	<p>1.4L / 1.6L Hdi 8V / 16V 1.4L / 1.5L / 1.6L TDCi / ECONetic 8V / 16V 1.4L / 1.6L TDCi 8V / 16V 1.6L 16V 1.4L DiD 8V 1.6L D4 16V</p>
	<p><b>Citroën:</b> C1, C2, C3 III, C3 Pluriel, C4 Picasso <b>Ford:</b> B-Max, C-Max, EcoSport, Fiesta, Focus, Focus C-Max, Fusion, Galaxy, Grand C-Max, Mondeo, S-Max, Tourneo Connect / Courier, Transit Connect / Courier <b>Peugeot:</b> 1007, 107, 206 CC / SW, 307 SW, 508 <b>Mazda:</b> 2 (DE/DH), 3 (BK/BL) <b>Mini:</b> Mini Clubman / Cooper / One (R55/R56) <b>Peugeot:</b> 1007, 107, 206 CC / SW, 307 SW, 508 <b>Toyota:</b> Aygo <b>Volvo:</b> C30, S40, S80, V50, V70</p>

REF



1747





680gr



10x

 Ferramentas para tensor correia Toyota  
 Herramientas para tensor de correia Toyota



	<p><b>PSA:</b> 1.4L, 1.5L, 1.6L, 2.0L, 2.2L (diesel) <b>VAG:</b> 1.8L, 2.0L (gasolina) / 1.9L, 2.0L (diesel) <b>FCA:</b> 0.9L TwinAir (gasolina)</p>
	<p><b>PSA 1.4L, 1.5L, 1.6L, 2.0L, 2.2L (diesel)</b> Citroën, DS, Fiat, Ford, Mazda, Mini, Mitsubishi, Opel, Peugeot, Suzuki, Toyota, Vauxhall, Volvo (DV4, DV5, DV6, DW10, DW12)</p> <p><b>VAG 1.8L, 2.0L gasolina</b> <b>VW:</b> Eos, Golf, Jetta, Passat, Polo, Scirocco, Touran; <b>AUDI:</b> A1, A3, TT; <b>SKODA:</b> Octavia; <b>SEAT:</b> Altea, Leon, Toledo</p> <p><b>VAG 1.9L, 2.0L diesel</b> <b>VW:</b> Caddy, Eos, Golf Plus, Jetta, Multivan T5, Passat, Sharan, Tiguan, Touran, Transporter T5; <b>AUDI:</b> A3; <b>SKODA:</b> Octavia, Superb; <b>SEAT:</b> Alhambra, Altea, Ibiza, Leon, Toledo</p> <p><b>FCA 0.9L TwinAir (gasolina)</b> <b>Fiat:</b> 500, 500L, Panda, Punto; <b>Alfa Romeo:</b> MiTo; <b>Lancia:</b> Ypsilon</p>

REF

1749





800gr



50x

 Ferramentas para tensor correia Volkswagen  
 Herramientas para tensor de correa Volkswagen

**VOLKSWAGEN**

	<b>PSA:</b> 1.4L, 1.5L, 1.6L, 2.0L, 2.2L (diesel) <b>VAG:</b> 1.8L, 2.0L (gasolina) / 1.9L, 2.0L (diesel) <b>FCA:</b> 0.9L TwinAir (gasolina)
	<b>PSA 1.4L, 1.5L, 1.6L, 2.0L, 2.2L (diesel)</b> Citroën, DS, Fiat, Ford, Mazda, Mini, Mitsubishi, Opel, Peugeot, Suzuki, Toyota, Vauxhall, Volvo (DV4, DV5, DV6, DW10, DW12)  <b>VAG 1.8L, 2.0L gasolina</b> <b>VW:</b> Eos, Golf, Jetta, Passat, Polo, Scirocco, Touran; <b>AUDI:</b> A1, A3, TT; <b>SKODA:</b> Octavia; <b>SEAT:</b> Altea, Leon, Toledo  <b>VAG 1.9L, 2.0L diesel</b> <b>VW:</b> Caddy, Eos, Golf Plus, Jetta, Multivan T5, Passat, Sharan, Tiguan, Touran, Transporter T5; <b>AUDI:</b> A3; <b>SKODA:</b> Octavia, Superb; <b>SEAT:</b> Alhambra, Altea, Ibiza, Leon, Toledo  <b>FCA 0.9L TwinAir (gasolina)</b> <b>Fiat:</b> 500, 500L, Panda, Punto; <b>Alfa Romeo:</b> MiTo; <b>Lancia:</b> Ypsilon



REF





1749

800gr

50x

 Kit tensor da correia auxiliar Volvo  
 Kit tensor de la correa auxiliar Volvo

**VOLVO**

	1.4L / 1.6L Hdi 8V / 16V 1.4L / 1.5L / 1.6L TDCi / EConetic 8V / 16V 1.4L / 1.6L TDCi 8V / 16V 1.6L 16V 1.4L DiD 8V 1.6L D4 16V
	<b>Citroën:</b> C1, C2, C3 III, C3 Pluriel, C4 Picasso <b>Ford:</b> B-Max, C-Max, EcoSport, Fiesta, Focus, Focus C-Max, Fusion, Galaxy, Grand C-Max, Mondeo, S-Max, Tourneo Connect / Courier, Transit Connect / Courier <b>Peugeot:</b> 1007, 107, 206 CC / SW, 307 SW, 508 <b>Mazda:</b> 2 (DE/DH), 3 (BK/BL) <b>Mini:</b> Mini Clubman / Cooper / One (R55/R56) <b>Peugeot:</b> 1007, 107, 206 CC / SW, 307 SW, 508 <b>Toyota:</b> Aygo <b>Volvo:</b> C30, S40, S80, V50, V70



REF





1747

680gr



10x

 Ferramentas para tensor correia Volvo  
 Herramientas para tensor de correa Volvo







	<p><b>PSA:</b> 1.4L, 1.5L, 1.6L, 2.0L, 2.2L (diesel) <b>VAG:</b> 1.8L, 2.0L (gasolina) / 1.9L, 2.0L (diesel) <b>FCA:</b> 0.9L TwinAir (gasolina)</p>
	<p><b>PSA 1.4L, 1.5L, 1.6L, 2.0L, 2.2L (diesel)</b> Citroën, DS, Fiat, Ford, Mazda, Mini, Mitsubishi, Opel, Peugeot, Suzuki, Toyota, Vauxhall, Volvo (DV4, DV5, DV6, DW10, DW12)</p> <p><b>VAG 1.8L, 2.0L gasolina</b> <b>VW:</b> Eos, Golf, Jetta, Passat, Polo, Scirocco, Touran; <b>AUDI:</b> A1, A3, TT; <b>SKODA:</b> Octavia; <b>SEAT:</b> Altea, Leon, Toledo</p> <p><b>VAG 1.9L, 2.0L diesel</b> <b>VW:</b> Caddy, Eos, Golf Plus, Jetta, Multivan T5, Passat, Sharan, Tiguan, Touran, Transporter T5; <b>AUDI:</b> A3; <b>SKODA:</b> Octavia, Superb; <b>SEAT:</b> Alhambra, Altea, Ibiza, Leon, Toledo</p> <p><b>FCA 0.9L TwinAir (gasolina)</b> <b>Fiat:</b> 500, 500L, Panda, Punto; <b>Alfa Romeo:</b> MiTo; <b>Lancia:</b> Ypsilon</p>

REF		
1749	800gr	50x

 Kit sincronização Volvo 1.5 Gasolina  
 Kit calado Volvo 1.5 Gasolina



	1.5L
	B3154T, B3154T2, B3154T4, B3154T5, B3154T7, B3154T9, B3154T10
	Volvo XC40 Recharge (2020 - ) T2 (2019), T3 (2018 - ) T4 "Twin Engine" (2019-2020) T5 "Twin Engine" (2019-2020), Recharge PHEV (2020 - )
	999 7690, 999 7697, 999 7676, 999 7674, 999 7675

 **NOTA:** Foto figurativa  
 **NOTA:** Foto ilustrativa

REF		
1752	2,5kg	5x



FERRAMENTA ELÉTRICA  
HERRAMIENTA ELÉCTRICA

09

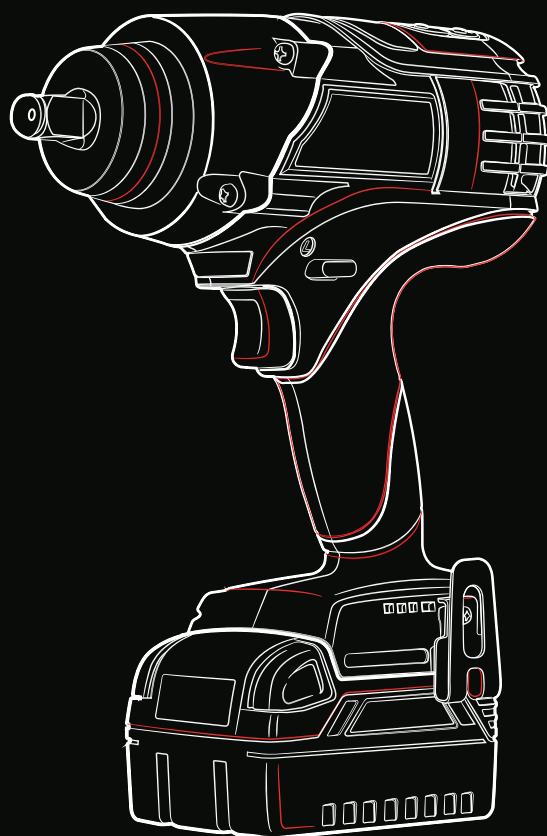

 <b>FAMÍLIA</b>	<b>PÁGINAS</b>
01 FERRAMENTA MANUAL	9-18
02 ALICATES	21-22
03 BITS E CONJUNTOS	25-28
04 FERRAMENTA ESPECÍFICA	31-37
05 FERRAMENTA CARROÇARIA	41-42
06 REGULAÇÃO E TESTE	45-48
07 FERRAMENTA MOTOR	51-52
08 KITS SINCRONIZAÇÃO	55-78
<b>09 FERRAMENTA ELÉTRICA</b>	<b>81-82</b>
10 FERRAMENTA PNEUMÁTICA	---
11 FERRAMENTA HIDRÁULICA	85-92
12 FERRAMENTA LUBRIFICAÇÃO	95-96
13 EQUIPAMENTO GARAGEM	99-112
RT ROUPA DE TRABALHO	115-116
MR MERCHANDISING	119-120
EP EXPOSITORES	---
LR LOCALIZAÇÃO REFERÊNCIAS	123-124

 <b>FAMILIA</b>	<b>PÁGINAS</b>
01 HERRAMIENTA MANUAL	9-18
02 ALICATES	21-22
03 PUNTAS Y CONJUNTOS	25-28
04 HERRAMIENTA ESPECÍFICA	31-37
05 HERRAMIENTA DE CARROCERIA	41-42
06 REGULACIÓN Y PRUEBAS	45-48
07 HERRAMIENTA PARA MOTOR	51-52
08 KITS CALADO	55-78
<b>09 HERRAMIENTA ELÉCTRICA</b>	<b>81-82</b>
10 HERRAMIENTA NEUMÁTICA	---
11 HERRAMIENTA HIDRÁULICA	85-92
12 HERRAMIENTA LUBRICACIÓN	95-96
13 EQUIPAMENTO PARA TALLER	99-112
RT ROPA DE TRABAJO	115-116
MR MERCHANDISING	119-120
EP EXPOSITORES	---
LR LOCALIZACIÓN REFERENCIAS	123-124

Gambiarra 5W LED com carregador 600LM  
 Lámpara 5W LED con estación de carga 600LM

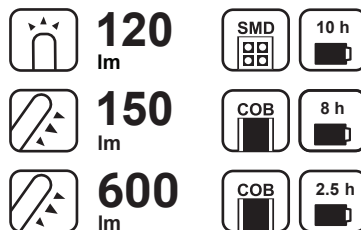
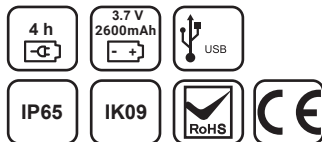

NOTA: Foto figurativa

NOTA: Foto ilustrativa

REF				
1158	2.5/8/10h	4h	391gr	12x

Gambiarra de cabeça LED COB com sensor de movimento 450LM  
 Faro LED COB con sensor de movimiento 450LM

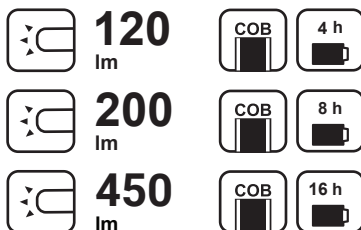
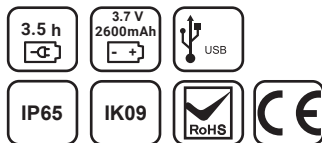

REF				
1159	4/8/16h	3.5h	210gr	40x

Gambiarra 1W LED recarregável magnética 100LM  
 Lámpara LED 1W recargable magnética 100LM

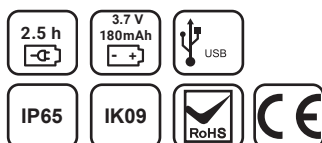

NOTA: Foto figurativa

NOTA: Foto ilustrativa

REF				
1160	6/2h	2.5h	124gr	50x



FERRAMENTA HIDRÁULICA  
HERRAMIENTA HIDRÁULICA

11

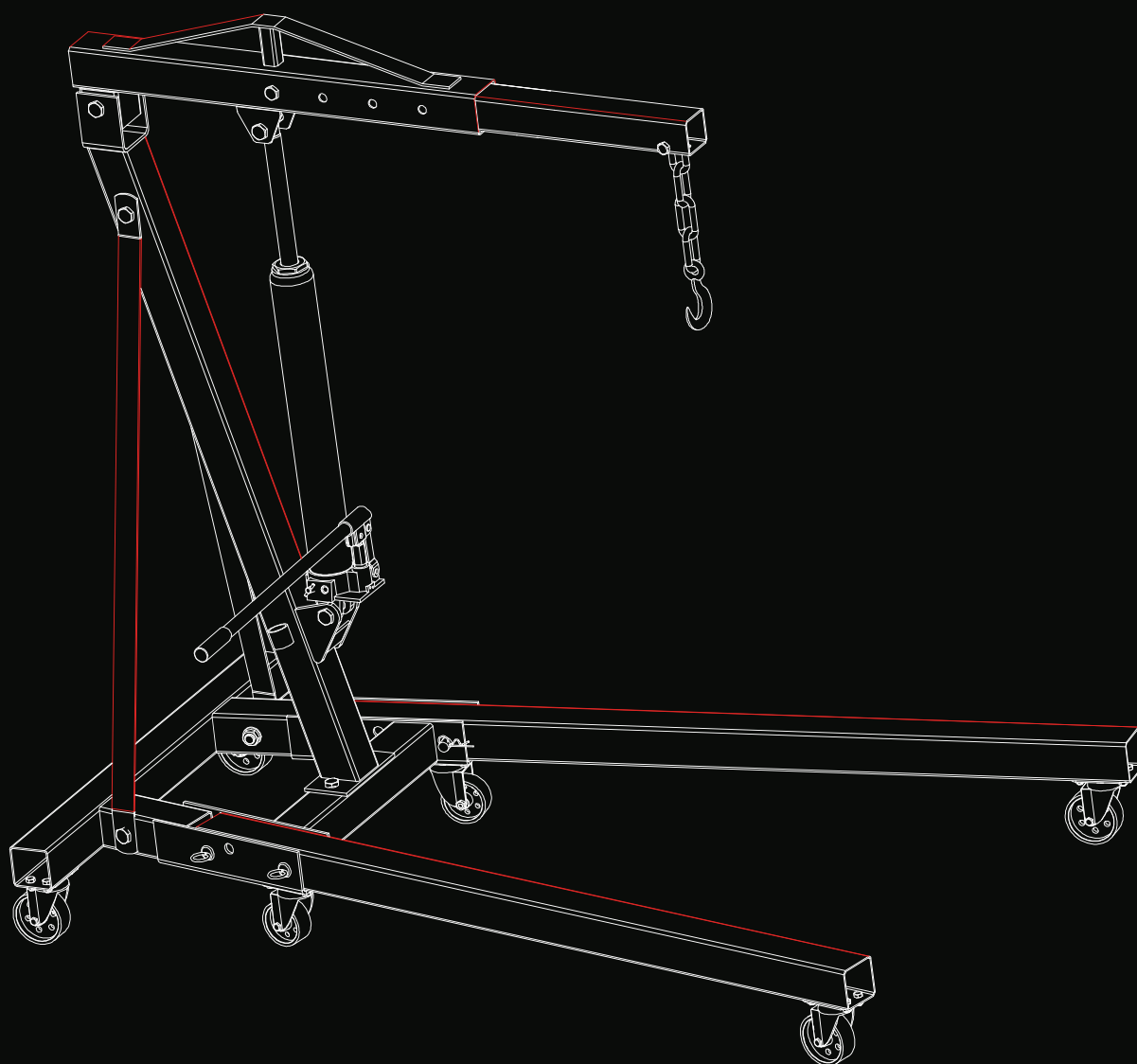

 <b>FAMÍLIA</b>	<b>PÁGINAS</b>
01 FERRAMENTA MANUAL	9-18
02 ALICATES	21-22
03 BITS E CONJUNTOS	25-28
04 FERRAMENTA ESPECÍFICA	31-37
05 FERRAMENTA CARROÇARIA	41-42
06 REGULAÇÃO E TESTE	45-48
07 FERRAMENTA MOTOR	51-52
08 KITS SINCRONIZAÇÃO	55-78
09 FERRAMENTA ELÉTRICA	81-82
10 FERRAMENTA PNEUMÁTICA	---
<b>11 FERRAMENTA HIDRÁULICA</b>	<b>85-92</b>
12 FERRAMENTA LUBRIFICAÇÃO	95-96
13 EQUIPAMENTO GARAGEM	99-112
RT ROUPA DE TRABALHO	115-116
MR MERCHANDISING	119-120
EP EXPOSITORES	---
LR LOCALIZAÇÃO REFERÊNCIAS	123-124

 <b>FAMILIA</b>	<b>PÁGINAS</b>
01 HERRAMIENTA MANUAL	9-18
02 ALICATES	21-22
03 PUNTAS Y CONJUNTOS	25-28
04 HERRAMIENTA ESPECÍFICA	31-37
05 HERRAMIENTA DE CARROCERIA	41-42
06 REGULACIÓN Y PRUEBAS	45-48
07 HERRAMIENTA PARA MOTOR	51-52
08 KITS CALADO	55-78
09 HERRAMIENTA ELÉCTRICA	81-82
10 HERRAMIENTA NEUMÁTICA	---
<b>11 HERRAMIENTA HIDRÁULICA</b>	<b>85-92</b>
12 HERRAMIENTA LUBRICACIÓN	95-96
13 EQUIPAMENTO PARA TALLER	99-112
RT ROPA DE TRABAJO	115-116
MR MERCHANDISING	119-120
EP EXPOSITORES	---
LR LOCALIZACIÓN REFERENCIAS	123-124

Macaco a bateria 15-30T curto

Gato corto de batería 15-30T

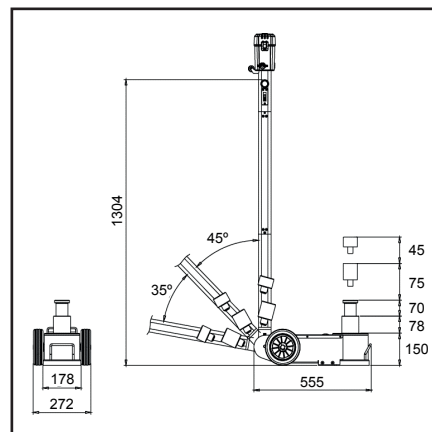

**Descrição:**  
Macaco a bateria, mais prático e eficiente  
Equipado com luz integrada que facilita a identificação do ponto de elevação em condições de pouca iluminação

**Características:**  
Capacidade da bateria 5000mAh  
Altura mínima: 150mm  
Altura máxima: 418mm

**Descripción:**  
Gato a batería, más práctico y eficiente  
Equipado con luz integrada que facilita la identificación del punto de elevación en condiciones de poca luz

**Características:**  
Capacidad de la batería: 5000mAh  
Altura mínima: 150mm  
Altura máxima: 418mm

REF

4916



15-30T



40kg



1x

Macaco a bateria 20-40T curto

Gato corto de batería 20-40T

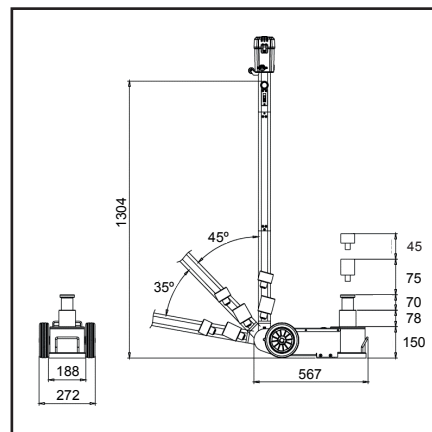

**Descrição:**  
Macaco a bateria, mais prático e eficiente  
Equipado com luz integrada que facilita a identificação do ponto de elevação em condições de pouca iluminação

**Características:**  
Capacidade da bateria 5000mAh  
Altura mínima: 150mm  
Altura máxima: 418mm

**Descripción:**  
Gato a batería, más práctico y eficiente  
Equipado con luz integrada que facilita la identificación del punto de elevación en condiciones de poca luz

**Características:**  
Capacidad de la batería: 5000mAh  
Altura mínima: 150mm  
Altura máxima: 418mm

REF

4917



20-40T



42kg



1x

 Macaco a bateria 15-30T longo

 Gato de batería longo 15-30T

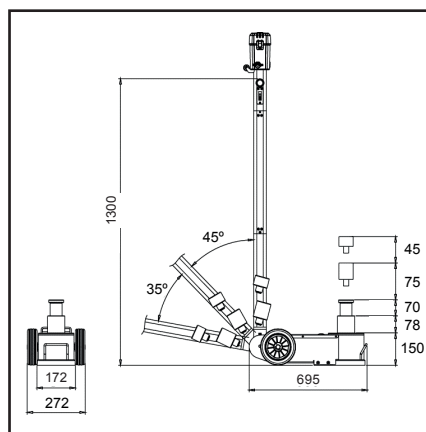

 **Descrição:**

Macaco a bateria, mais prático e eficiente  
Equipado com luz integrada que facilita a identificação do ponto de elevação em condições de pouca iluminação

**Características:**

Capacidade da bateria 5000mAh

Altura mínima: 150mm

Altura máxima: 418mm

 **Descripción:**

Gato a batería, más práctico y eficiente  
Equipado con luz integrada que facilita la identificación del punto de elevación en condiciones de poca luz

**Características:**

Capacidad de la batería: 5000mAh

Altura mínima: 150mm

Altura máxima: 418mm

REF

4918



15-30T



45kg



1x

 Macaco a bateria 20-40T longo

 Gato de batería longo 20-40T

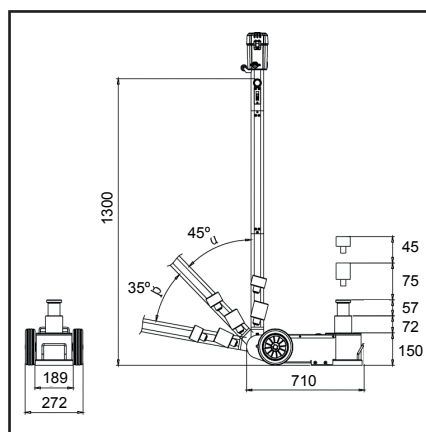

 **Descrição:**

Macaco a bateria, mais prático e eficiente  
Equipado com luz integrada que facilita a identificação do ponto de elevação em condições de pouca iluminação

**Características:**

Capacidade da bateria 5000mAh

Altura mínima: 150mm

Altura máxima: 399mm

 **Descripción:**

Gato a batería, más práctico y eficiente  
Equipado con luz integrada que facilita la identificación del punto de elevación en condiciones de poca luz

**Características:**

Capacidad de la batería: 5000mAh

Altura mínima: 150mm

Altura máxima: 399mm

REF

4919



20-40T



49kg



1x

Macaco a bateria 15/30/50T longo  
Gato de batería longo 15/30/50T

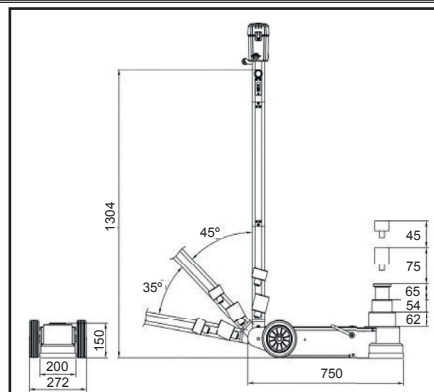

**Descrição:**  
Macaco a bateria, mais prático e eficiente  
Equipado com luz integrada que facilita a identificação do ponto de elevação em condições de pouca iluminação  
**Características:**  
Curso de elevação: 181mm  
Potência nominal (W): 600W  
Capacidade da bateria (mAh): 5000mAh  
Quantidade de baterias: 2 unidades por macaco

**Descripción:**  
Gato a batería, más práctico y eficiente.  
Equipado con luz integrada que facilita la identificación del punto de elevación en condiciones de poca luz.  
**Características:**  
Recorrido de elevación: 181mm  
Potencia nominal (W): 600W  
Capacidad de la batería (mAh): 5000mAh  
Cantidad de baterías: 2 unidades por gato

REF			
4921	15-30-50T	58kg	1x

Macaco hidro-pneumático rodas 6Ton - chassi longo  
Gato de piso de chasis largo 6Ton



**Descrição:**  
Macacos hidráulicos de serviço pesado com chassi longo, concebidos para levantar cargas, mas não para as suportar de forma permanente  
Equipados com a tecnologia FTL (Fast to Load – Rápido a Carregar)  
**Características:**  
Altura mínima: 150mm  
Altura máxima: 650mm  
Altura de elevação com carga: 400-650mm

**Descripción:**  
Gatos hidráulicos de servicio pesado con chasis largo, diseñados para levantar cargas, pero no para soportarlas de forma permanente  
Equipados con la tecnología FTL (Fast to Load – Rápido de Cargar)  
**Características:**  
Altura mínima: 150mm  
Altura máxima: 650mm  
Altura de elevación con carga: 400-650mm

NOTA: Foto figurativa  
NOTA: Foto ilustrativa

REF			
4909	6T	84,4kg	1x



Macaco elétrico 0.5Ton



Gato eléctrico de transmisión 0.5Ton



**Caraterísticas:**

Capacidade nominal: 0.5 toneladas  
 Altura mínima: 950mm  
 Altura máxima: 1950mm  
 Adaptar a marca da bateria  
 Tensão: 18V/8AH



**Caraterísticas:**

Capacidad nominal: 0.5 toneladas  
 Altura mínima: 950mm  
 Altura máxima: 1950mm  
 Adaptar a la marca de la batería  
 Tensión: 18V/8AH

REF

4834





0.5T



69.5kg



1x

 Prensa elétrica 20 ton com cilindro móvel  
 Prensa eléctrica de 20 ton con cilindro móvil

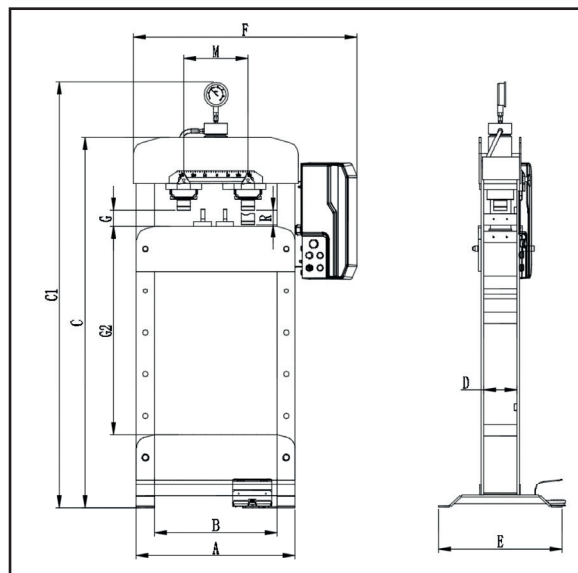

 **Características:**  
Alcance de trabalho: 48-910mm  
Dimensões: 850x540x1830mm  
A-850mm, B-540mm, C-1602mm, C1-1830mm, D-134mm, E-540mm, F-990mm, G1/G2-48-910mm, R-180mm, M-260mm

 **Características:**  
Rango de trabajo: 48-910mm  
Dimensiones: 850\*540\*1830mm  
A-850mm, B-540mm, C-1602mm, C1-1830mm, D-134mm, E-540mm, F-990mm, G1/G2-48-910mm, R-180mm, M-260mm

REF

4980



20T



116kg



1x

 Prensa elétrica 30 ton com cilindro móvel  
 Prensa eléctrica de 30 ton con cilindro móvil

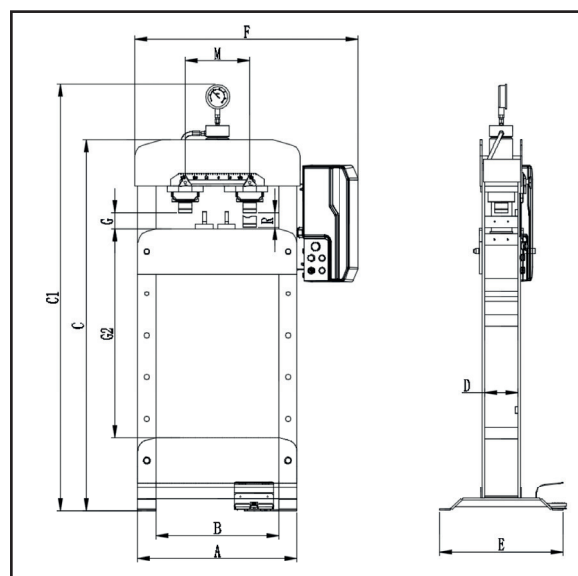

 **Características:**  
Alcance de trabalho: 75-990mm  
Dimensões: 850x540x1850mm  
A-850mm, B-540mm, C-1650mm, C1-1850mm, D-148mm, E-540mm, F-990mm, G1/G2-75-990mm, R-180mm, M-240mm

 **Características:**  
Rango de trabajo: 75-990mm  
Dimensiones: 850x540x1850mm  
A-850mm, B-540mm, C-1650mm, C1-1850mm, D-148mm, E-540mm, F-990mm, G1/G2-75-990mm, R-180mm, M-240mm

REF

4985





30T





152kg

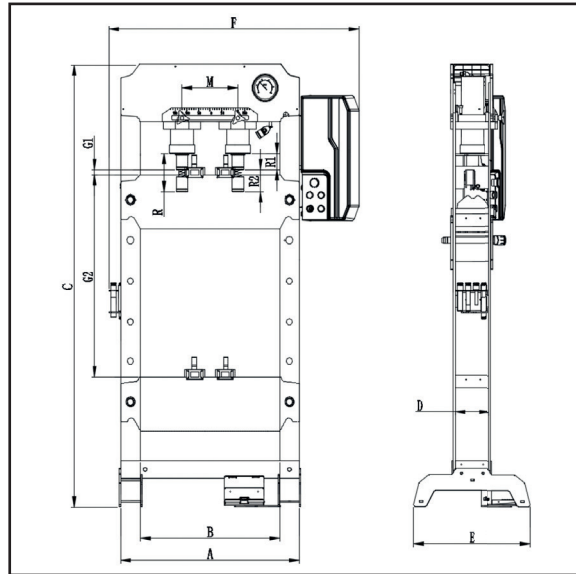

1x

-  Prensa elétrica 50 ton com cilindro móvel
-  Prensa eléctrica de 50 ton con cilindro móvil



 **Características:**

Alcance de trabalho: 80-780mm  
 Dimensões: 930x750x1900mm  
 A-930mm, B-750mm, C-1900mm, D-200mm, E-535mm,  
 F-1240mm, G1/G2-80-780mm, R-220mm, R1-145mm, R2-75mm,  
 M-280mm

 **Características:**

Rango de trabajo: 80-780mm  
 Dimensiones: 930x750x1900mm  
 A-930mm, B-750mm, C-1900mm, D-200mm, E-535mm,  
 F-1240mm, G1/G2-80-780mm, R-220mm, R1-145mm, R2-75mm,  
 M-280mm

REF

4990



50T



255kg



1x

 Prensa hidráulica 50T dupla velocidade e pedal

 Prensa hidráulica 50T

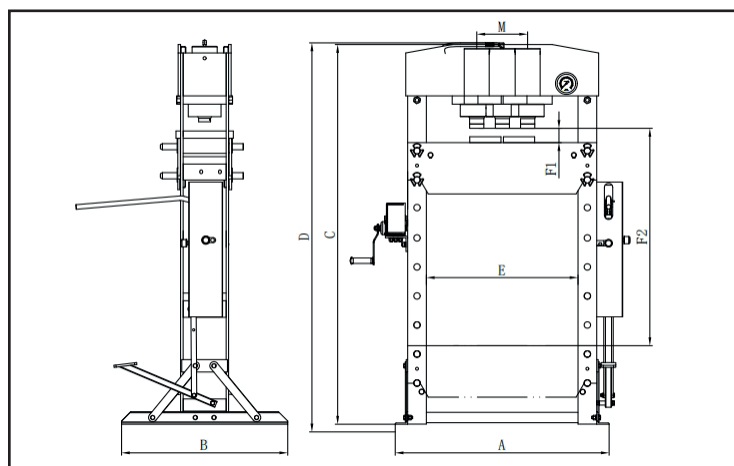

 **Características:**

Curso: 200mm  
Alcance de trabalho: 61-1040mm  
Dimensões: A-1016mm, B-740mm, C-1834mm, D-1884mm,  
E-730mm, F-214mm, F1/F2-61-1040mm, M-245mm

 **Características:**

Curso: 200mm  
Rango de trabajo: 61-1040mm  
Dimensiones: A-1016mm, B-740mm, C-1834mm, D-1884mm,  
E-730mm, F-214mm, F1/F2-61-1040mm, M-245mm

REF  
4893

  
50T

  
242,8kg

  
1x



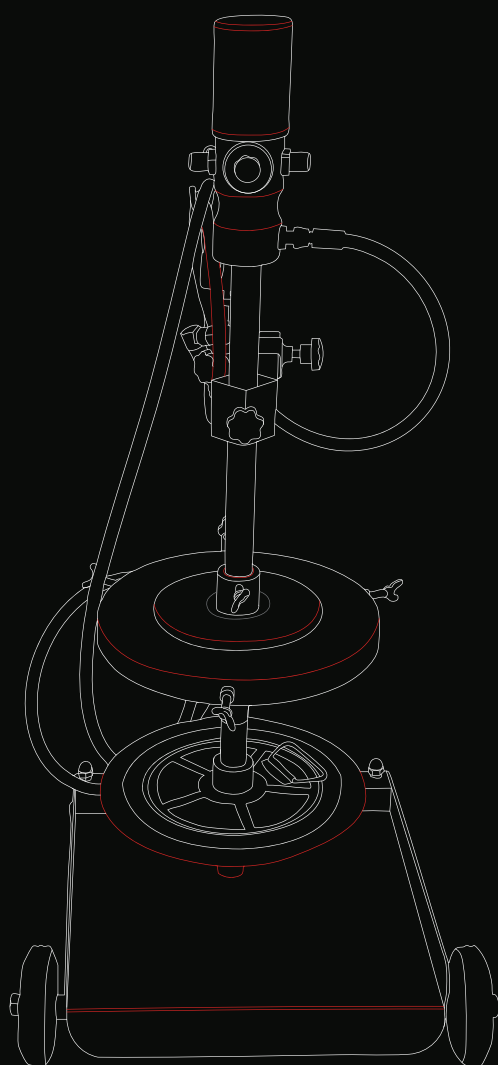

FERRAMENTA LUBRIFICAÇÃO  
HERRAMIENTA LUBRICACIÓN

12



 <b>FAMÍLIA</b>	<b>PÁGINAS</b>
01 FERRAMENTA MANUAL	9-18
02 ALICATES	21-22
03 BITS E CONJUNTOS	25-28
04 FERRAMENTA ESPECÍFICA	31-37
05 FERRAMENTA CARROÇARIA	41-42
06 REGULAÇÃO E TESTE	45-48
07 FERRAMENTA MOTOR	51-52
08 KITS SINCRONIZAÇÃO	55-78
09 FERRAMENTA ELÉTRICA	81-82
10 FERRAMENTA PNEUMÁTICA	---
11 FERRAMENTA HIDRÁULICA	85-92
<b>12 FERRAMENTA LUBRIFICAÇÃO</b>	<b>95-96</b>
13 EQUIPAMENTO GARAGEM	99-112
RT ROUPA DE TRABALHO	115-116
MR MERCHANDISING	119-120
EP EXPOSITORES	---
LR LOCALIZAÇÃO REFERÊNCIAS	123-124

 <b>FAMILIA</b>	<b>PÁGINAS</b>
01 HERRAMIENTA MANUAL	9-18
02 ALICATES	21-22
03 PUNTAS Y CONJUNTOS	25-28
04 HERRAMIENTA ESPECÍFICA	31-37
05 HERRAMIENTA DE CARROCERIA	41-42
06 REGULACIÓN Y PRUEBAS	45-48
07 HERRAMIENTA PARA MOTOR	51-52
08 KITS CALADO	55-78
09 HERRAMIENTA ELÉCTRICA	81-82
10 HERRAMIENTA NEUMÁTICA	---
11 HERRAMIENTA HIDRÁULICA	85-92
<b>12 HERRAMIENTA LUBRICACIÓN</b>	<b>95-96</b>
13 EQUIPAMENTO PARA TALLER	99-112
RT ROPA DE TRABAJO	115-116
MR MERCHANDISING	119-120
EP EXPOSITORES	---
LR LOCALIZACIÓN REFERENCIAS	123-124

-  Bomba de óleo elétrica
-  Bomba de aceite eléctrica



 **Descrição:**

A bomba elétrica de óleo foi concebida para utilização direta em bidões de grande capacidade para transferência de óleo. Apresenta design compacto, é de fácil transporte e garante funcionamento simples. É amplamente utilizada na indústria automóvel, na engenharia mecânica e noutras aplicações de injeção de óleo

**Gama de óleos aplicáveis:** óleos lubrificantes, como óleo de motor, óleo de engrenagens e anticongelante, com viscosidade inferior a 90 SAE

**Características:**

Tensão de funcionamento do motor: DC21V  
 Capacidade da bateria: 2.5Ah  
 Tensão nominal da bateria: 18.5V  
 Tensão de carregamento da bateria: 21V  
 Potência do motor: 200W  
 Conetor de saída de óleo: 1/2"  
 Caudal de transferência: 6L/min  
 Temperatura do óleo: -10°C a 60°C  
 Viscosidade do óleo: SAE 90  
 Comprimento do tubo de sucção: 875mm  
 Diâmetro do tubo rígido: 30mm

 **Descripción:**

La bomba eléctrica de aceite ha sido concebida para su uso directo en bidones de gran capacidad para la transferencia de aceite. Presenta un diseño compacto, es de fácil transporte y garantiza un funcionamiento sencillo. Se utiliza ampliamente en la industria del automóvil, en la ingeniería mecánica y en otras aplicaciones de inyección de aceite

**Gama de aceites aplicables:** aceites lubricantes, como aceite de motor, aceite de engranajes y anticongelante, con una viscosidad inferior a SAE 90

**Características:**

Tensión de funcionamiento del motor: DC21V  
 Capacidad de la batería: 2.5Ah  
 Tensión nominal de la batería: 18.5V  
 Tensión de carga de la batería: 21V  
 Potencia del motor: 200W  
 Conector de salida de aceite: 1/2"  
 Caudal de transferencia: 6L/min  
 Temperatura del aceite: -10°C a 60°C  
 Viscosidad del aceite: SAE 90  
 Longitud del tubo de aspiración: 875mm  
 Diámetro del tubo rígido: 30mm

REF

8345



5,5kg



1x

 Bomba rotativa manual alto caudal - bidão 205L

 Bomba rotativa de alto flujo - bidón de 205L



 **Descrição:**

Fabricada em alumínio fundido e aço galvanizado, adequada para bombear fluidos de baixa viscosidade e não corrosivos, como gasóleo, óleo e anticongelante, a partir de tambores de 205L

**Características:**

Tipo de bomba: Palhetas rotativas

Fluxo: 1 litro por rotação

Adaptador de rosca: 50mm BSP

 **Descripción:**

Fabricada en aluminio fundido y acero galvanizado, adecuada para bombear fluidos de baja viscosidad y no corrosivos, como gasóleo, aceite y anticongelante, desde bidones de 205L

**Características:**

Tipo de bomba: Palas rotativas

Caudal: 1 litro por revolución

Adaptador de rosca: 50mm BSP

REF



3277

5,5kg

1x

 Bomba rotativa manual com adaptador para berbequim

 Bomba rotativa manual con adaptador para talandro



 **Descrição:**

Bomba rotativa manual adequada para a transferência de líquidos a partir de bidões de 56,78L, 113,56L e 189,27L

Com um adaptador, pode também ser acionada por uma ferramenta elétrica

**Caraterísticas:**

Caudal: até 10 GPM

Capacidade: 0.3L por curso

Adaptador de rosca: 2"

Comprimento do tubo de sucção: 1060mm

Diâmetro do tubo de sucção: 25mm

Bocal de saída: 3/4" com encaixe cónico escalonado

 **Descripción:**

Bomba rotativa manual adecuada para la transferencia de líquidos desde bidones de 56,78L, 113,56L y 189,27L

Con un adaptador, también puede accionarse mediante una herramienta eléctrica

**Caraterísticas:**

Caudal: hasta 10 GPM

Capacidad: 0.3L por carrera

Adaptador roscado: 2"

Longitud del tubo de aspiración: 1060mm

Diámetro del tubo de aspiración: 25mm

Boquilla de descarga: 3/4" con ajuste cónico escalonado

REF



8326

2,25kg

6x

**EQUIPAMENTO GARAGEM**  
**EQUIPAMENTO PARA TALLER**

**13**

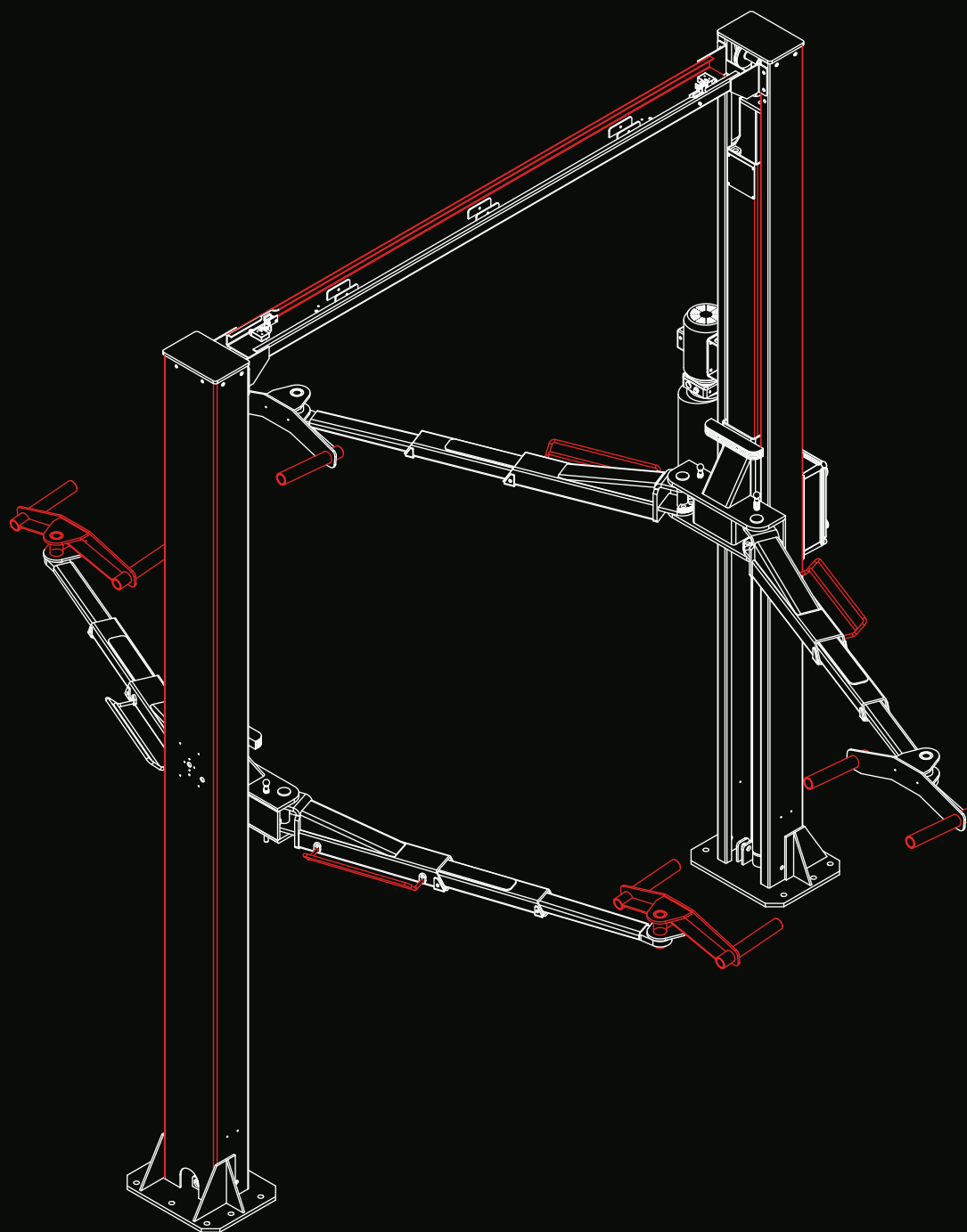

 <b>FAMÍLIA</b>	<b>PÁGINAS</b>
01 FERRAMENTA MANUAL	9-18
02 ALICATES	21-22
03 BITS E CONJUNTOS	25-28
04 FERRAMENTA ESPECÍFICA	31-37
05 FERRAMENTA CARROÇARIA	41-42
06 REGULAÇÃO E TESTE	45-48
07 FERRAMENTA MOTOR	51-52
08 KITS SINCRONIZAÇÃO	55-78
09 FERRAMENTA ELÉTRICA	81-82
10 FERRAMENTA PNEUMÁTICA	---
11 FERRAMENTA HIDRÁULICA	85-92
12 FERRAMENTA LUBRIFICAÇÃO	95-96
<b>13 EQUIPAMENTO GARAGEM</b>	<b>99-112</b>
RT ROUPA DE TRABALHO	115-116
MR MERCHANDISING	119-120
EP EXPOSITORES	---
LR LOCALIZAÇÃO REFERÊNCIAS	123-124

 <b>FAMILIA</b>	<b>PÁGINAS</b>
01 HERRAMIENTA MANUAL	9-18
02 ALICATES	21-22
03 PUNTAS Y CONJUNTOS	25-28
04 HERRAMIENTA ESPECÍFICA	31-37
05 HERRAMIENTA DE CARROCERIA	41-42
06 REGULACIÓN Y PRUEBAS	45-48
07 HERRAMIENTA PARA MOTOR	51-52
08 KITS CALADO	55-78
09 HERRAMIENTA ELÉCTRICA	81-82
10 HERRAMIENTA NEUMÁTICA	---
11 HERRAMIENTA HIDRÁULICA	85-92
12 HERRAMIENTA LUBRICACIÓN	95-96
<b>13 EQUIPAMENTO PARA TALLER</b>	<b>99-112</b>
RT ROPA DE TRABAJO	115-116
MR MERCHANDISING	119-120
EP EXPOSITORES	---
LR LOCALIZACIÓN REFERENCIAS	123-124

Enrolador ar 12,5x18,8mm 15M PVC  
Enrollador aire 12,5x18,8mm 15M PVC

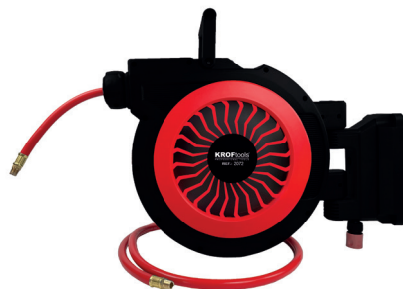

Rosca cobre 1/4" BSPT  
Acoplador de cobre 1/4" BSPT



REF 2077

Engates de ar não incluídos  
Acoplamientos de aire no incluidos

**Características:**  
Medidas (C x L x A): 617x271x446mm  
Diâmetro da mangueira: 12,5x18,8mm  
Adaptador: 3/8" BSPT  
Pressão de trabalho/explosão: 150PSI

**Características:**  
Medidas (C x L x A): 617x271x446mm  
Diâmetro de la manguera: 12.5x18.8mm  
Encaje: 3/8" BSPT  
Presión de trabajo/de ráfaga: 150PSI

REF

2072

12,5x18,8mm

15+1m

10,2kg

1x

Enrolador ar 7,5x11,5mm 10M PVC  
Enrollador aire 7,5x11,5mm 10M PVC



Rosca cobre 1/4" BSPT  
Acoplador de cobre 1/4" BSPT



REF 2077

Engates de ar não incluídos  
Acoplamientos de aire no incluidos

**Características:**  
Medidas (C x L x A): 395x150x315mm  
Diâmetro mangueira: 7,5x11,5mm  
Adaptador: 1/4" BSPT  
Pressão de trabalho: 120PSI

**Características:**  
Medidas (C x L x A): 395x150x315mm  
Diâmetro de la manguera: 7,5x11,5mm  
Encaje: 1/4" BSPT  
Presión de trabajo: 120PSI

REF

2074

7,5x11,5mm

10+1m

17kg

4x

Enrolador de ar 8x12mm 15M  
Enrollador de aire 8x12mm 15M



Rosca cobre 1/4" BSPT  
Acoplador de cobre 1/4" BSPT



REF 2077

Engates de ar não incluídos  
Acoplamientos de aire no incluidos

**Características:**  
Medidas (C x L x A): 420x182.5x328mm  
Diâmetro da mangueira: 8x12mm  
Adaptador: 1/4"BSPT + EURO conector rápido  
Pressão de trabalho: 120PSI

**Características:**  
Medidas (C x L x A): 420x182.5x328mm  
Diâmetro de la manguera: 8x12mm  
Encaje: 1/4"BSPT + conector rápido EURO  
Presión de trabajo: 120PSI

REF

2084

8x12mm

15+1,5m

10kg

2x

Enrolador de ar 10x14.5mm 20M  
Enrollador de aire 10x14.5mm 20M

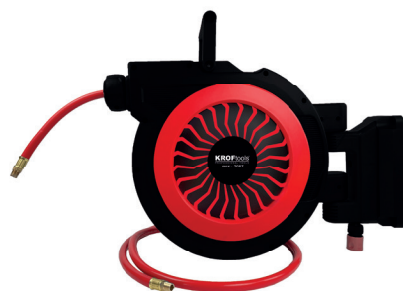

Rosca cobre 1/4" BSPT  
Acoplador de cobre 1/4" BSPT



REF 2077

Engates de ar não incluídos  
Acoplamientos de aire no incluidos

**Características:**  
Medidas (C x L x A): 617x271x446mm  
Diâmetro da mangueira: 10x14,50mm  
Adaptador: 1/4"BSPT  
Pressão de trabalho: 120PSI

**Características:**  
Medidas (C x L x A): 617x271x446mm  
Diâmetro de la manguera: 10x14,50mm  
Encaje: 1/4"BSPT  
Presión de trabajo: 120PSI

REF



2087

10x14,50mm

20+2m

10,3kg

1x

-  Enrolador ar 8x12mm 20M  
 Enrollador de aire 8x12mm 20M





Rosca cobre 1/4" BSPT  
Acoplador de cobre 1/4" BSPT





REF 2077

-  Engates de ar não incluídos  
 Acoplamientos de aire no incluídos

 **Características:**  
 Medidas (C x L x A): 420x182,5x328mm  
 Diâmetro da mangueira: 8x12mm  
 Adaptador: 1/4" BSPT  
 Pressão de trabalho: 120PSI

 **Características:**  
 Medidas (C x L x A): 420x182,5x328mm  
 Diámetro de la manguera: 8x12mm  
 Encaje: 1/4" BSPT  
 Presión de trabajo: 120PSI





REF				
2088	8x12mm	20+2m	7,9kg	2x



-  Enrolador água 1/2" 15M  
 Enrollador agua 1/2" 15M



 **Características:**  
 Medidas (C x L x A): 420x182.5x328mm  
 Diâmetro mangueira: 1/2"  
 Adaptador: 3/4"  
 Pressão de trabalho: 120PSI

 **Características:**  
 Medidas (C x L x A): 420x182.5x328mm  
 Diámetro de la manguera: 1/2"  
 Encaje: 3/4"  
 Presión de trabajo: 120PSI

REF				
2080	1/2"	15+1,5m	3,95kg	2x



-  Enrolador elétrico cabo 3x1,5mm 15M  
 Enrollador electrico 3x1,5mm 15M



 **Características:**  
 Medidas (C x L x A): 395x150x315mm  
 Diâmetro da mangueira: 3x1,5mm  
 Voltagem: 230V  
 Potência: 1000W/3000W

 **Características:**  
 Medidas (C x L x A): 395x150x315mm  
 Diámetro de la manguera: 3x1,5mm  
 Tensión: 230V  
 Potencia: 1000W/3000W

REF				
2085	3x1,5mm	15+1,5m	5kg	4x

-  Aparadeira de óleo 76L com bomba elétrica
-  Recipiente para drenar aceite 76L con bomba eléctrica



**NOTA:** Foto figurativa  
**NOTA:** Foto ilustrativa

**Características:**

Dimensões: 1065x975x269mm  
Capacidade máxima do tanque: 76L  
Espessura do material: 1.2mm  
Material: Aço SPCC  
Método de drenagem de óleo: Bomba elétrica  
Especificações da bomba: 12V – 300W  
Caudal máximo: 13L/min  
Altura máxima de bombeamento: 10m  
Tubo de drenagem de óleo: 1/2"x1.8m

**Conteúdo:**

(1x) Bomba 12V-300W  
(1x) Redutor de bucha 3/4"x1/2"  
(1x) Conjunto 3/4" x 4 peças (20–45°) para conexões de mangueira  
(1x) Tampa da bomba  
(1x) Pega em T  
(4x) Rodas  
(18x) Parafusos hexagonais M8x16  
(8x) Parafusos M4x5  
(8x) Juntas M4  
(1x) Fita PTFE (vedante de roscas)  
(1x) Tubo de PVC Φ19xΦ26xL160mm  
(2x) Braçadeiras para mangueira (4 unid. Ø26mm + 4 unid. Ø32mm)  
(1x) Tanque de óleo  
(1x) Bandeja anti-respingos  
(1x) Mangueira de drenagem de óleo 1/2"x1800mm (com cotovelo metálico)

**Características:**

Dimensiones: 1065x975x269mm  
Capacidad máxima del depósito: 76L  
Espesor del material: 1.2mm  
Material: Acero SPCC  
Método de drenaje de aceite: Bomba eléctrica  
Especificaciones de la bomba: 12V – 300W  
Caudal máximo: 13L/min  
Altura máxima de bombeo: 10m  
Tubo de drenaje de aceite: 1/2"x1.8m

**Contenido:**

(1x) Bomba 12V-300W  
(1x) Reductor de buje 3/4"x1/2"  
(1x) Conjunto 3/4" x 4 piezas (20–45°) para conexiones de mangueira  
(1x) Tapa de la bomba  
(1x) Asa en T  
(4x) Ruedas  
(18x) Tornillos hexagonales M8x16  
(8x) Tornillos M4x5  
(8x) Juntas M4  
(1x) Cinta PTFE (selladora de roscas)  
(1x) Tubo de PVC Φ19xΦ26xL160mm  
(2x) Abrazaderas para mangueira (4 uds Ø26mm + 4 uds Ø32mm)  
(1x) Depósito de aceite  
(1x) Bandeja anti-salpicaduras  
(1x) Mangueira de drenaje de aceite 1/2"x1800mm (con codo metálico)

REF

9724



27kg



1x

 Aspirador óleo + aparadeira reservatório 68L

 Aspirador aceite + recogedor con depósito de 68L

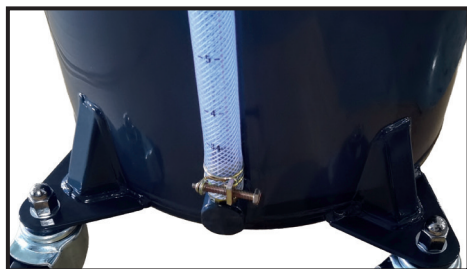

 **Características:**

Medidas: 553x400x1900mm  
 Rodas giratórias: 76mm  
 Rodas fixas: 152mm  
 Capacidade: 68L  
 Gama de elevação: 1170 a 1900mm  
 Intervalo de pressão: 0-0,16MPa / 0-23psi  
 Mangueira:  $\Phi 19 \times \Phi 25$  comprimento 2500mm

 **Características:**

Medidas: 553x400x1900mm  
 Ruedas giratorias: 76mm  
 Ruedas fijas: 152mm  
 Capacidad: 68L  
 Rango de elevación: 1170 a 1900mm  
 Intervalo de presión: 0-0,16MPa / 0-23psi  
 Manguera:  $\Phi 19 \times \Phi 25$  longitud 2500mm

REF

9705



23,2kg



1x

- Aspirador óleo com visor 3 gavetas 61pcs
- Aspirador aceite con visualizador 3 cajones 61pzs



**Características:**  
 Pressão de alimentação de ar: 6-8bar  
 Pressão de descarga: 0.6-0.8bar  
 Consumo de ar: 150 L/min  
 Grau de vácuo: 0-65 cmHg  
 Capacidade do depósito: 70L  
 Capacidade do copo medidor: 10L  
 Capacidade da bandeja de recolha de óleo: 10L  
 Temperatura de funcionamento do óleo: 40-80°C

Tubos de sucção de óleo: 5 uni  
 Φ5 × 700 mm (PVC, 1 unid.):  
 Débito de sucção: 1.9 L/min  
 Φ6 × 700 mm (PVC, 2 unid.):  
 Débito de sucção: 3.7 L/min  
 Φ8 × 700 mm (PVC, 2 unid.):  
 Débito de sucção: 6.5 L/min

**Características:**  
 Presión de suministro de aire: 6-8bar  
 Presión de descarga: 0.6-0.8bar  
 Consumo de aire: 150L/min  
 Grado de vacío: 0-65cmHg  
 Capacidad del depósito: 70L  
 Capacidad del vaso medidor: 10L  
 Capacidad de la bandeja recolectora de aceite: 10L  
 Temperatura de trabajo del aceite: 40-80°C

Tubos de succión de aceite: 5 uni  
 Φ5 × 700 mm (PVC, 1 ud.): Caudal de succión: 1.9 L/min  
 Φ6 × 700 mm (PVC, 2 uds.):  
 Caudal de succión: 3.7 L/min  
 Φ8 × 700 mm (PVC, 2 uds.):  
 Caudal de succión: 6.5 L/min

REF



9715

84kg



1x

- Aspirador óleo com visor 3 gavetas vazio
- Aspirador aceite con visualizador 3 cajones vacio



**Características:**  
 Pressão de alimentação de ar: 6-8bar  
 Pressão de descarga: 0.6-0.8bar  
 Consumo de ar: 150 L/min  
 Grau de vácuo: 0-65 cmHg  
 Capacidade do depósito: 70L  
 Capacidade do copo medidor: 10L  
 Capacidade da bandeja de recolha de óleo: 10L  
 Temperatura de funcionamento do óleo: 40-80°C

Tubos de sucção de óleo: 5 unidades  
 Φ5 × 700 mm (PVC, 1 unid.):  
 Débito de sucção: 1.9 L/min  
 Φ6 × 700 mm (PVC, 2 unid.):  
 Débito de sucção: 3.7 L/min  
 Φ8 × 700 mm (PVC, 2 unid.):  
 Débito de sucção: 6.5 L/min

**Características:**  
 Presión de suministro de aire: 6-8bar  
 Presión de descarga: 0.6-0.8bar  
 Consumo de aire: 150L/min  
 Grado de vacío: 0-65cmHg  
 Capacidad del depósito: 70L  
 Capacidad del vaso medidor: 10L  
 Capacidad de la bandeja recolectora de aceite: 10L  
 Temperatura de trabajo del aceite: 40-80°C

Tubos de succión de aceite: 5 unidades  
 Φ5 × 700 mm (PVC, 1 ud.): Caudal de succión: 1.9 L/min  
 Φ6 × 700 mm (PVC, 2 uds.):  
 Caudal de succión: 3.7 L/min  
 Φ8 × 700 mm (PVC, 2 uds.):  
 Caudal de succión: 6.5 L/min

REF





9716

74kg



1x

 **Kit ferramentas troca óleo 61pcs**  
 **Juego de herramientas para cambio de aceite de 61pzs**



 **Composição:**

- (1x) Chave filtro óleo 64-65mm x 14pt LEXUS, CROWIN
- (1x) Chave filtro óleo 64-65mm x 14pt LEXUS
- (1x) Chave filtro óleo 74mm x 8pt FIAT, VOLKSWAGEN
- (1x) Chave filtro óleo 88-89mm x 15pt ISUZU, HONDA, MITSUBISHI
- (1x) Chave filtro óleo 91-92mm x 15pt SOUTHEASTDECALT, ISUZU
- (1x) Chave filtro óleo 92-93mm x 15pt JEEP, HONDA, TOYOTA
- (1x) Chave filtro óleo 73mm x 15pt BUICK, GM, MITSUBISHI, CHRYSLER
- (1x) Chave filtro óleo 86,3mm x 16pt VOLVO
- (1x) Chave filtro óleo 73-74mm x 15pt GM, CHRYSLER
- (1x) Chave filtro óleo 101mm x 15pt DAIHATSU, MAZDA, MITSUBISHI, TOYOTA
- (1x) Chave filtro óleo 93-94mm x 15pt CROWN(OLDITM), TOYOTA, GM, FORD, CHRYSLER
- (1x) Chave filtro óleo 95.5-85.2mm x 16pt LYNK&CO
- (1x) Chave filtro óleo 74-75mm x 14pt POLO
- (1x) Chave filtro óleo 86-87mm x 16pt VOLVO
- (1x) Chave filtro óleo 80mm x 12pt FORD, MAXDA, MITSUBISHI, DAIHATSU, PEUGEOT, RENAULT, CITROEN
- (1x) Chave filtro óleo 79-80mm x 15pt HINO, TOYOTA, GM, FORD, CHRYSLER
- (1x) Chave filtro óleo 86mm x 18pt PEUGEOT, RENAULT, CITROEN
- (1x) Chave filtro óleo 73-74mm x 14pt BEBENZ, BMW, VOLKSWAGEN, AUDI, OPEL, HYUNDAI, KIA, CHERY
- (1x) Chave filtro óleo 75-76mm x 15pt GM, CHRYSLER, FORD, MAZDA
- (1x) Chave filtro óleo 64-65mm x 14pt TOYOTA, MARUTI, NISSAN, CHARADE, GEELY, HONDA
- (1x) Chave filtro óleo 90-91mm x 15pt TOYOTA, JMC, ISUZU
- (1x) Chave filtro óleo 66-67mm x 14pt FORD, MITSUBISHI, MAZDA, HYUNDAI, KIA, SUZUKI, GEELY
- (1x) Chave filtro óleo 89mm x 12pt CHANGANSTAR
- (1x) Chave filtro óleo 78-79mm x 15pt HONDA, HYUNDAI, KIA, FORD, DAIHATSU, NISSAN, TOYOTA, SUZUKI
- (1x) Chave filtro óleo 77mm x 12pt RENAULT, PEUGEOT
- (1x) Chave filtro óleo 72-73mm x 14pt LEXUS, VIZI, CROWN, TOYOTA
- (1x) Chave filtro óleo 84mm x 14pt CITROEN Y.C
- (1x) Chave filtro óleo 106-107mm x 15pt VOLVO, IVECO, RENAULT, SCANIA
- (1x) Chave filtro óleo 105mm x 15pt VOLVO, SCANIA, RENAULT, MAN, IVECO, FIAT, FODEN, IRISBU, ASTRA, CATERPILLAR, LIEBHERR, JOHN DEERE, KOMATSU, FAUN, MITSUBISHI
- (1x) Chave filtro óleo 36mm x 6pt BENZ, AUDI AL, BMW/M52 M60 M73, VOLKSIACEN
- (1x) Chave filtro óleo 27mm x 6pt MERCEDES-BENZ
- (1x) Chave filtro óleo 32mm x 6pt GM-SATUM, AUDI, VW, OPEL
- (1x) Chave de algemas média 80-100 mm
- (1x) Chave 3x1/2 (125 mm, 250 mm)
- (1x) Chave de algemas pequena 65-85 mm
- (1x) Chave de anel 251 mm
- (1x) Chave Allen
- (9x) Chaves de boca quadradas (5/16" - 3/8" - 7 - 8 - 10 - 11 - 12 - 13 - 14 mm)
- (7x) Chaves de boca hexagonais (8 - 9 - 10 - 12 - 13 - 14 - 17 mm)
- (1x) Chave de encaixe M16
- (1x) Chave torx T45
- (1x) Chave triangular 10 mm
- (1x) Chave 10 mm
- (2x) barra de extensão (3" e 6"-75 mm-150 mm)
- (1x) Barra T deslizante (150 mm)

 **Composición:**

- (1x) Llave para filtro de aceite 64-65mm x 14pt LEXUS, CROWIN
- (1x) Llave para filtro de aceite 64-65mm x 14pt LEXUS
- (1x) Llave para filtro de aceite 74mm x 8pt FIAT, VOLKSWAGEN
- (1x) Llave para filtro de aceite 88-89mm x 15pt ISUZU, HONDA, MITSUBISHI
- (1x) Llave para filtro de aceite 91-92mm x 15pt SOUTHEASTDECALT, ISUZU
- (1x) Llave para filtro de aceite 92-93mm x 15pt JEEP, HONDA, TOYOTA
- (1x) Llave para filtro de aceite 73mm x 15pt BUICK, GM, MITSUBISHI, CHRYSLER
- (1x) Llave para filtro de aceite 86,3mm x 16pt VOLVO
- (1x) Llave para filtro de aceite 73-74mm x 15pt GM, CHRYSLER
- (1x) Llave para filtro de aceite 101mm x 15pt DAIHATSU, MAZDA, MITSUBISHI, TOYOTA
- (1x) Llave para filtro de aceite 93-94mm x 15pt CROWN(OLDITM), TOYOTA, GM, FORD, CHRYSLER
- (1x) Llave para filtro de aceite 95.5-85.2mm x 16pt LYNK&CO
- (1x) Llave para filtro de aceite 74-75mm x 14pt POLO
- (1x) Llave para filtro de aceite 86-87mm x 16pt VOLVO
- (1x) Llave para filtro de aceite 80mm x 12pt FORD, MAXDA, MITSUBISHI, DAIHATSU, PEUGEOT, RENAULT, CITROEN
- (1x) Llave para filtro de aceite 79-80mm x 15pt HINO, TOYOTA, GM, FORD, CHRYSLER
- (1x) Llave para filtro de aceite 86mm x 18pt PEUGEOT, RENAULT, CITROEN
- (1x) Llave para filtro de aceite 73-74mm x 14pt BEBENZ, BMW, VOLKSWAGEN, AUDI, OPEL, HYUNDAI, KIA, CHERY
- (1x) Llave para filtro de aceite 75-76mm x 15pt GM, CHRYSLER, FORD, MAZDA
- (1x) Llave para filtro de aceite 64-65mm x 14pt TOYOTA, MARUTI, NISSAN, CHARADE, GEELY, HONDA
- (1x) Llave para filtro de aceite 90-91mm x 15pt TOYOTA, JMC, ISUZU
- (1x) Llave para filtro de aceite 66-67mm x 14pt FORD, MITSUBISHI, MAZDA, HYUNDAI, KIA, SUZUKI, GEELY
- (1x) Llave para filtro de aceite 89mm x 12pt CHANGANSTAR
- (1x) Llave para filtro de aceite 78-79mm x 15pt HONDA, HYUNDAI, KIA, FORD, DAIHATSU, NISSAN, TOYOTA, SUZUKI
- (1x) Llave para filtro de aceite 77mm x 12pt RENAULT, PEUGEOT
- (1x) Llave para filtro de aceite 72-73mm x 14pt LEXUS, VIZI, CROWN, TOYOTA
- (1x) Llave para filtro de aceite 84mm x 14pt CITROEN Y.C
- (1x) Llave para filtro de aceite 106-107mm x 15pt VOLVO, IVECO, RENAULT, SCANIA
- (1x) Llave para filtro de aceite 105mm x 15pt VOLVO, SCANIA, RENAULT, MAN, IVECO, FIAT, FODEN, IRISBU, ASTRA, CATERPILLAR, LIEBHERR, JOHN DEERE, KOMATSU, FAUN, MITSUBISHI
- (1x) Llave para filtro de aceite 36mm x 6pt BENZ, AUDI AL, BMW/M52 M60 M73, VOLKSWAGEN
- (1x) Llave para filtro de aceite 27mm x 6pt MERCEDES-BENZ
- (1x) Llave para filtro de aceite 32mm x 6pt GM-SATUM, AUDI, VW, OPEL
- (1x) Llave para filtro de aceite 36mm x 6pt BENZ, AUDI AL, BMW/M52 M60 M73, VOLKSWAGEN
- (1x) Llave para filtro de aceite 27mm x 6pt MERCEDES-BENZ
- (1x) Llave para filtro de aceite 32mm x 6pt GM-SATUM, AUDI, VW, OPEL
- (1x) Llave para esposas mediana 80-100mm
- (1x) Llave 3x1/2 (125 mm, 250 mm)
- (1x) Llave pequeña para esposas 65-85 mm
- (3x) Llave de anillo 251 mm
- (1x) Llave Allen
- (9x) Enchufes cuadrados (5/16" - 3/8" - 7 - 8 - 10 - 11 - 12 - 13 - 14mm)
- (7x) Casquillos hexagonales (8 - 9 - 10 - 12 - 13 - 14 - 17mm)
- (1x) Llave de vaso con ranura M16
- (1x) Llave de vaso Torx T45
- (1x) Llave de vaso triangular 10mm
- (1x) Llave de vaso 10mm
- (2x) Barras de extensión (3" y 6"-75mm-150mm)
- (1x) barra en T deslizante (150 mm)

REF



9717



10,6kg



1x

 **Máquina limpeza peças ultrasónica 30L**  
 **Limpiador ultrasónico de piezas de 30L**



 **NOTA:** Foto figurativa  
**NOTA:** Foto ilustrativa

 **Características:**

Dimensões do tanque: 500x300x200mm  
Dimensões da unidade: 530x325x325mm  
Frequência: 50Hz  
Frequência das ondas ultra-sónicas: 40kHz  
Transdutores: 10pcs  
Capacidade: 30L  
Potência de aquecimento: 500W  
Potência ultra-sónica: 600W  
Tensão: CA 220–240V, 50Hz  
Tempo: 0–30min  
Temperatura: ambiente ~80°C

 **Características:**

Tamaño del tanque: 500x300x200mm  
Tamaño de la unidad: 530x325x325mm  
Frecuencia: 50Hz  
Frecuencia de las ondas ultrasónicas: 40kHz  
Transductores: 10pcs  
Capacidad: 30L  
Potencia de calefacción: 500W  
Potencia ultrasónica: 600W  
Tensión: CA 220–240V, 50Hz  
Tiempo: 0–30min  
Temperatura: ambiente ~80°C

REF



9746



13,5kg



1x

 **Desengordorante para lavar peças 20L**  
 **Desengrasante para lavar piezas 20L**



 **Aplicação:**

Produto concentrado, a utilizar diretamente ou diluído em água quente (temperatura máxima 60°C)  
Adequado para utilização em máquinas de limpeza manual de peças

**Características:**

Tensoativos não iónicos:  $5 \leq \%(\text{p/p}) < 15$   
Densidade a 20°C: 1032 kg/m<sup>3</sup>  
pH: 8  
Ponto de ebulição à pressão atmosférica: 107°C  
Ponto de inflamação: não inflamável (>60°C)  
Temperatura mínima de armazenamento: 5°C  
Temperatura máxima de armazenamento: 30°C  
Diluição recomendada: 20% em água

**NOTA:** Compatível com Máquina de Lavar Peças a Quente, Ref: 9775

 **Aplicación:**

Producto concentrado, para utilizar directamente o diluido en agua caliente (temperatura máxima 60°C)  
Adequado para su uso en máquinas de limpieza manual de piezas

**Características:**

Tensioactivos no iónicos:  $5 \leq \%(\text{p/p}) < 15$   
Densidad a 20°C: 1032 kg/m<sup>3</sup>  
pH: 8  
Punto de ebullición a presión atmosférica: 107°C  
Punto de inflamación: no inflamable (>60°C)  
Temperatura mínima de almacenamiento: 5°C  
Temperatura máxima de almacenamiento: 30°C  
Dilución recomendada: 20% en agua

**NOTA:** Compatible con la máquina lavadora de piezas en caliente, Ref.: 9775

REF

9739



21kg





30x

 Micro esferas de vidro 100-300

 Microesferas de vidro 100-300



 **Granulometria:** 0,10-0,30mm  
 Compatível com as Máquinas de decapar Ref.:9760, 9765, 9770, 9771, 9772

 **Granulometría:** 0,10-0,30 mm  
 Compatible con las máquinas de decapado Ref.: 9760, 9765, 9770, 9771, 9772

REF



9763

20kg

48x

 Suporte de rolos para desmontador de pneus automática

 Soporte de rodillos para desmontadora de ruedas automática



 **Características:**  
 Material: ferro  
 Dimensões do produto: 455 x 305 x 35 mm

 **Características:**  
 Material: hierro  
 Dimensões do produto: 455 x 305 x 35 mm

REF



9049

4,7kg

1x

 Kit cone 121-174mm e flange 180mm - diâmetro 40mm

 Kit cono 121-174mm e brida 180mm diâmetro 40mm



 **Características:**  
 Material: ferro fundido, acabamento preto  
 Dimensões do produto: 235 x 235 x 70mm  
 Diâmetro interno: 180mm  
**NOTA:** Compatível com Máquinas de Calibrar Rodas, Ref: 9045 e 9048

 **Características:**  
 Material: hierro fundido, acabado negro  
 Tamaño del producto: 235 x 235 x 70mm  
 Diámetro interno: 180mm  
**NOTA:** Compatible con Equilibradoras de Ruedas, Ref: 9045 y 9048

REF



9068

6,2kg

1x

 Suporte segurança 3T para macaco rodas com pino de segurança

 Soporte de seguridad 3T para gato de ruedas y pasador de seguridad



 **Características:**  
 Capacidade máxima de carga: 3T  
 Comprimento útil: 200 a 350mm, em incrementos de 25mm  
 Comprimento total: 230mm a 380mm

 **Características:**  
 Capacidad máxima de carga: 3T  
 Longitud útil: 200 a 350mm, en incrementos de 25mm  
 Longitud total: 230mm a 380mm

 **NOTA:** Foto figurativa  
 **NOTA:** Foto ilustrativa

REF



4758

1,75kg

10x

Caixa pesos roda com clip plástico 5g 100pcs  
Contrapesa con clip plástico 5g 100pzs



REF		
9090	500gr	16x

Caixa pesos roda com clip plástico 10g 100pcs  
Contrapesa con clip plástico 10g 100pzs



REF		
9091	1kg	16x

Caixa pesos roda com clip plástico 15g 100pcs  
Contrapesa con clip plástico 15g 100pzs



REF		
9092	1,5kg	8x

Caixa pesos roda com clip plástico 20g 100pcs  
Contrapesa con clip plástico 20g 100pzs



REF		
9093	2kg	8x

Caixa pesos roda com clip plástico 30g 100pcs  
Contrapesa con clip plástico 30g 100pzs





REF		
9094	3kg	4x

Caixa pesos roda com clip plástico 45g 50pcs  
Contrapesa con clip plástico 45g 50pzs



REF		
9095	2,25kg	4x

-  Suporte motor rotativo 550kg  
 Soporte de motor rotativo 550kg

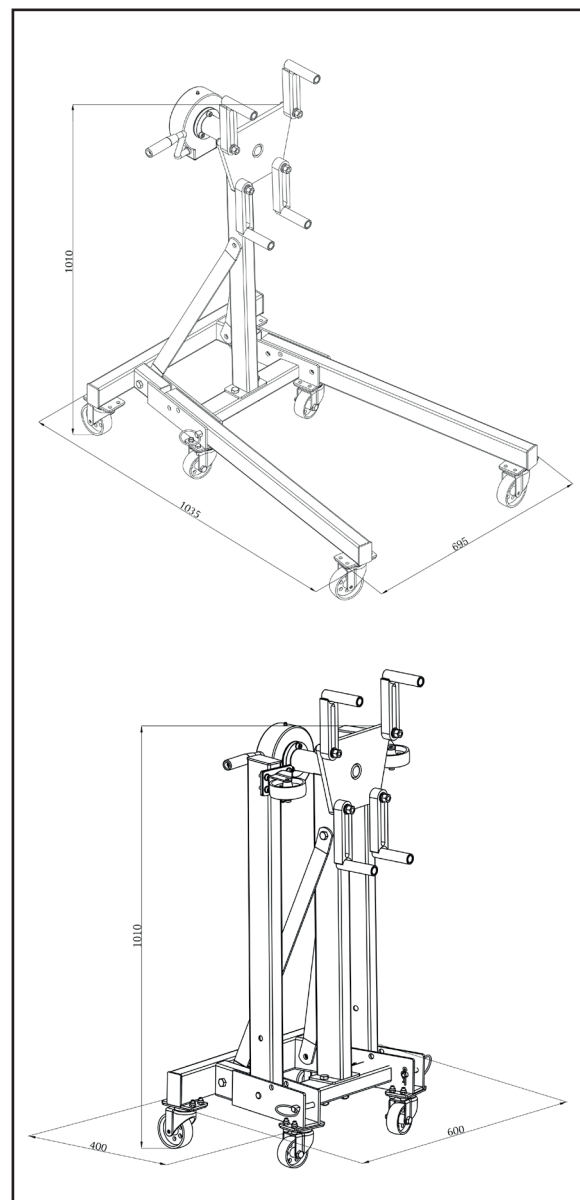

 **Descrição:**

Este suporte de motor é utilizado para fixar motores automóveis fora do veículo, facilitando o acesso durante operações de manutenção ou reparação

**Caraterísticas:**

Capacidade: 550kg  
 Dimensões dobradas: 1035x695x1010mm  
 Dimensões montadas: 600x400x1010mm

 **Descripción:**

Este soporte de motor se utiliza para fijar motores de automóviles fuera del vehículo, facilitando el acceso durante las operaciones de mantenimiento o reparación

**Características:**

Capacidad: 550kg  
 Dimensiones plegada: 1035x695x1010mm  
 Dimensiones montado: 600x400x1010mm

REF

4854



46kg



1x

- Máquina troca líquido refrigeração 15L
- Máquina de intercambio de líquido refrigerante 15L



**Características:**

- Capacidade do depósito de fluido novo: 15L
- Capacidade do depósito de fluido usado: 15L
- Velocidade de sucção de óleo: 0 - 3L/min
- Velocidade de descarga de óleo: 0 - 4L/min
- Pressão de trabalho: 5 - 8bar
- Grau de vácuo: -0.1 - 0bar
- Pressão de descarga de óleo: 0 - 0.5bar
- Dimensões do equipamento: 600 x 430 x 1270mm

**Características:**

- Capacidad del depósito de fluido nuevo: 15L
- Capacidad del depósito de fluido usado: 15L
- Velocidad de succión de aceite: 0 - 3L/min
- Velocidad de descarga de aceite: 0 - 4L/min
- Presión de trabajo: 5 - 8bar
- Grado de vacío: -0.1 - 0bar
- Presión de descarga -e aceite: 0 - 0.5bar
- Dimensiones del equipo: 600 x 430 x 1270mm

REF



9044

38kg



1x

- Braço reto 920-1700mm
- Brazo recto de 920-1700mm



REF





9875B1700

62kg



1x

 Elevador móvel 2,5T

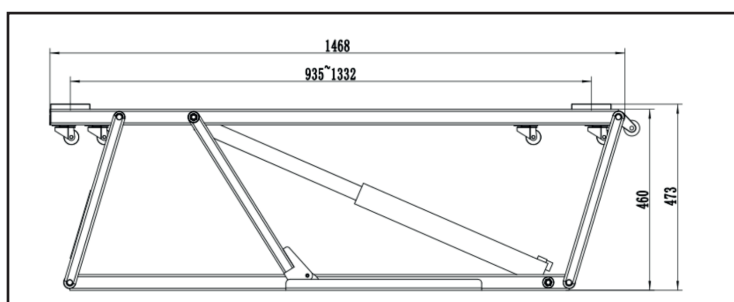
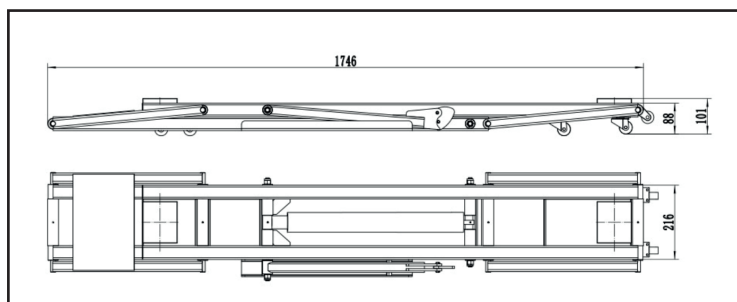
 Elevador móvil 2,5T

 **Caraterísticas:**

Capacidade de elevação: 2500kg  
 Altura rebaixada (apenas estrutura): 88mm  
 Altura rebaixada (com blocos de borracha de 50mm): 101mm  
 Altura rebaixada (com blocos de borracha de 70mm): 21mm  
 Altura de elevação (apenas estrutura): 460mm  
 Altura de elevação (com blocos de borracha de 50mm): 473mm  
 Altura de elevação (com blocos de borracha de 70mm): 493mm  
 Comprimento da estrutura de elevação: 1780mm  
 Distância entre pontos de elevação (máxima): 1432mm  
 Distância entre pontos de elevação (mínimo): 835mm  
 Largura da estrutura de elevação: 320mm  
 Tempo para elevação total: 35segundos  
 Tempo de descida: 48segundos  
 Configuração PRV da unidade de potência: 6-20MPa  
 Pressão máxima de operação: 18MPa  
 Nível de ruído (elevação): <60dB  
 Velocidade máxima do vento para operação segura: 48km/h  
 Capacidade do tanque de óleo: 4L

 **Características**

Capacidad de elevación: 2500kg  
 Altura rebajada (solo bastidor): 88mm  
 Altura rebajada (con bloques de goma de 50mm): 101mm  
 Altura rebajada (con bloques de goma de 70mm): 21mm  
 Altura de elevación (solo bastidor): 460mm  
 Altura de elevación (con bloques de goma de 50mm): 473mm  
 Altura de elevación (con bloques de goma de 70mm): 493mm  
 Longitud del bastidor de elevación: 1780mm  
 Distancia entre puntos de elevación (máxima): 1432mm  
 Distancia entre puntos de elevación (mínimo): 835mm  
 Ancho del bastidor de elevación: 320mm  
 Tiempo hasta la elevación completa: 35segundos  
 Tiempo de descenso: 48segundos  
 Ajuste PRV de la unidad de potencia: 6-20MPa  
 Presión máxima de funcionamiento: 18MPa  
 Nivel de ruido (elevación): <60dB  
 Velocidad máxima del viento para un funcionamiento seguro: 48km/h  
 Capacidad del depósito de aceite: 4L

REF



9813



62,6kg



1x

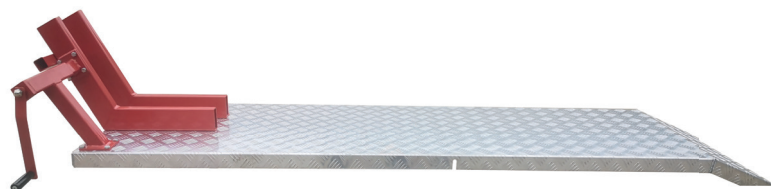

-  Kit de elevação para motos para 9813
-  Kit elevador para motocicletas para 9813





NOTA: Foto figurativa  
NOTA: Foto ilustrativa

**Características:**  
Comprimento da plataforma: 2120mm  
Comprimento da plataforma com rampa: 2360mm  
Comprimento total (plataforma + rampa + extensão do suporte): 2760mm  
Largura da plataforma: 720mm  
Largura da plataforma (incluindo a manivela): 940mm

**Características:**  
Longitud de la plataforma: 2120mm  
Longitud de la plataforma con rampa: 2360mm  
Longitud total (plataforma + rampa + extensión del soporte): 2760mm  
Anchura de la plataforma: 720mm  
Anchura de la plataforma (incluyendo la manivela): 940mm

REF		
9814	36,5kg	1x



-  Kit suporte de parede para 9813
-  Kit soporte de pared para 9813



**Medidas:**  
Largura: 120 mm  
Altura: 160 mm

**Medidas:**  
Ancho: 120 mm  
Altura: 160 mm

REF		
9821	10kg	1x

-  Bloco de borracha para 9813
-  Bloque de goma para 9813



**Medidas:**  
Comprimento: 101mm  
Largura: 75mm  
Altura: 75mm

**Medidas:**  
Longitud: 101mm  
Ancho: 75mm  
Altura: 75mm

REF		
9846	680gr	4x



**ROUPA DE TRABALHO**

**ROPA DE TRABAJO**



**RT**



**KROFtools**<sup>®</sup>  
PROFESSIONAL TOOLS

 <b>FAMÍLIA</b>	<b>PÁGINAS</b>
01 FERRAMENTA MANUAL	9-18
02 ALICATES	21-22
03 BITS E CONJUNTOS	25-28
04 FERRAMENTA ESPECÍFICA	31-37
05 FERRAMENTA CARROÇARIA	41-42
06 REGULAÇÃO E TESTE	45-48
07 FERRAMENTA MOTOR	51-52
08 KITS SINCRONIZAÇÃO	55-78
09 FERRAMENTA ELÉTRICA	81-82
10 FERRAMENTA PNEUMÁTICA	---
11 FERRAMENTA HIDRÁULICA	85-92
12 FERRAMENTA LUBRIFICAÇÃO	95-96
13 EQUIPAMENTO GARAGEM	99-112
<b>RT ROUPA DE TRABALHO</b>	<b>115-116</b>
MR MERCHANDISING	119-120
EP EXPOSITORES	---
LR LOCALIZAÇÃO REFERÊNCIAS	123-124

 <b>FAMILIA</b>	<b>PÁGINAS</b>
01 HERRAMIENTA MANUAL	9-18
02 ALICATES	21-22
03 PUNTAS Y CONJUNTOS	25-28
04 HERRAMIENTA ESPECÍFICA	31-37
05 HERRAMIENTA DE CARROCERIA	41-42
06 REGULACIÓN Y PRUEBAS	45-48
07 HERRAMIENTA PARA MOTOR	51-52
08 KITS CALADO	55-78
09 HERRAMIENTA ELÉCTRICA	81-82
10 HERRAMIENTA NEUMÁTICA	---
11 HERRAMIENTA HIDRÁULICA	85-92
12 HERRAMIENTA LUBRICACIÓN	95-96
13 EQUIPAMENTO PARA TALLER	99-112
<b>RT ROPA DE TRABAJO</b>	<b>115-116</b>
MR MERCHANDISING	119-120
EP EXPOSITORES	---
LR LOCALIZACIÓN REFERENCIAS	123-124

 Luvas com palma em poliuretano - 1 par  
 Guantes con palma de poliuretano - 1 par



 Normas de Qualidade e Certificação: EN388-2016

 Normas de Calidad y Certificaciones: EN388-2016

REF	Tamanho/Talla		
6007	7	83gr	12x / 240x
6008	8	83gr	12x / 240x
6009	9	83gr	12x / 240x
6010	10	83gr	12x / 240x



**MERCHANDISING**  
**MERCHANDISING**

**MR**



**KROFtools**<sup>®</sup>  
PROFESSIONAL TOOLS

 <b>FAMÍLIA</b>	<b>PÁGINAS</b>
01 FERRAMENTA MANUAL	9-18
02 ALICATES	21-22
03 BITS E CONJUNTOS	25-28
04 FERRAMENTA ESPECÍFICA	31-37
05 FERRAMENTA CARROÇARIA	41-42
06 REGULAÇÃO E TESTE	45-48
07 FERRAMENTA MOTOR	51-52
08 KITS SINCRONIZAÇÃO	55-78
09 FERRAMENTA ELÉTRICA	81-82
10 FERRAMENTA PNEUMÁTICA	---
11 FERRAMENTA HIDRÁULICA	85-92
12 FERRAMENTA LUBRIFICAÇÃO	95-96
13 EQUIPAMENTO GARAGEM	99-112
RT ROUPA DE TRABALHO	115-116
<b>MR MERCHANDISING</b>	<b>119-120</b>
EP EXPOSITORES	---
LR LOCALIZAÇÃO REFERÊNCIAS	123-124

 <b>FAMILIA</b>	<b>PÁGINAS</b>
01 HERRAMIENTA MANUAL	9-18
02 ALICATES	21-22
03 PUNTAS Y CONJUNTOS	25-28
04 HERRAMIENTA ESPECÍFICA	31-37
05 HERRAMIENTA DE CARROCERIA	41-42
06 REGULACIÓN Y PRUEBAS	45-48
07 HERRAMIENTA PARA MOTOR	51-52
08 KITS CALADO	55-78
09 HERRAMIENTA ELÉCTRICA	81-82
10 HERRAMIENTA NEUMÁTICA	---
11 HERRAMIENTA HIDRÁULICA	85-92
12 HERRAMIENTA LUBRICACIÓN	95-96
13 EQUIPAMENTO PARA TALLER	99-112
RT ROPA DE TRABAJO	115-116
<b>MR MERCHANDISING</b>	<b>119-120</b>
EP EXPOSITORES	---
LR LOCALIZACIÓN REFERENCIAS	123-124

- Saco tipo mochila com cordão kroftools
- Bolsa de cordón kroftools



**Características:**  
Medidas: 34x42cm  
Material: poliéster 210

**Características:**  
Medidas: 34x42cm  
Material: poliéster 210

REF		
BAGC	100gr	500x

- Garrafa 500ml kroftools
- Botella 500ml kroftools



**Características:**  
Tecnologia de isolamento a vácuo de parede dupla  
Design à prova de fugas  
Fácil de limpar  
Materiais sem BPA  
Durável e leve

**Características:**  
Tecnología de aislamiento al vacío de doble pared  
Diseño a prueba de fugas  
Fácil de limpiar  
Materiales sin BPA  
Duradero y ligero

REF		
GARRAFA2	500gr	25x



LOCALIZAÇÃO REFERÊNCIAS  
LOCALIZACIÓN REFERENCIAS

LR

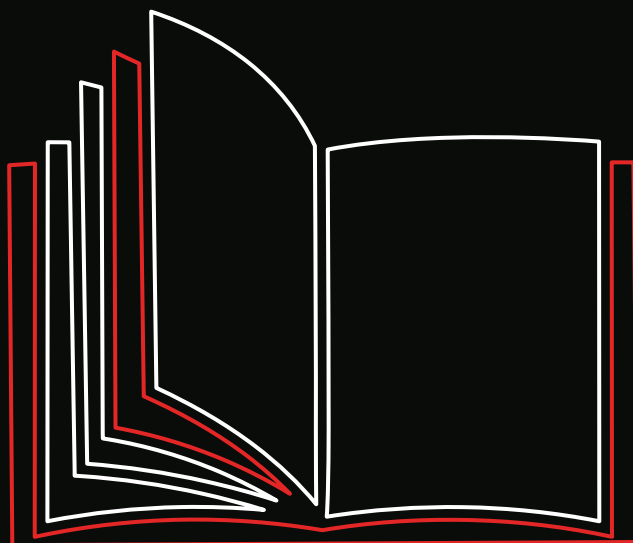

 <b>FAMÍLIA</b>	<b>PÁGINAS</b>
01 FERRAMENTA MANUAL	9-18
02 ALICATES	21-22
03 BITS E CONJUNTOS	25-28
04 FERRAMENTA ESPECÍFICA	31-37
05 FERRAMENTA CARROÇARIA	41-42
06 REGULAÇÃO E TESTE	45-48
07 FERRAMENTA MOTOR	51-52
08 KITS SINCRONIZAÇÃO	55-78
09 FERRAMENTA ELÉTRICA	81-82
10 FERRAMENTA PNEUMÁTICA	---
11 FERRAMENTA HIDRÁULICA	85-92
12 FERRAMENTA LUBRIFICAÇÃO	95-96
13 EQUIPAMENTO GARAGEM	99-112
RT ROUPA DE TRABALHO	115-116
MR MERCHANDISING	119-120
EP EXPOSITORES	---
<b>LR LOCALIZAÇÃO REFERÊNCIAS</b>	<b>123-124</b>

 <b>FAMILIA</b>	<b>PÁGINAS</b>
01 HERRAMIENTA MANUAL	9-18
02 ALICATES	21-22
03 PUNTAS Y CONJUNTOS	25-28
04 HERRAMIENTA ESPECÍFICA	31-37
05 HERRAMIENTA DE CARROCERIA	41-42
06 REGULACIÓN Y PRUEBAS	45-48
07 HERRAMIENTA PARA MOTOR	51-52
08 KITS CALADO	55-78
09 HERRAMIENTA ELÉCTRICA	81-82
10 HERRAMIENTA NEUMÁTICA	---
11 HERRAMIENTA HIDRÁULICA	85-92
12 HERRAMIENTA LUBRICACIÓN	95-96
13 EQUIPAMENTO PARA TALLER	99-112
RT ROPA DE TRABAJO	115-116
MR MERCHANDISING	119-120
EP EXPOSITORES	---
<b>LR LOCALIZACIÓN REFERENCIAS</b>	<b>123-124</b>

Referência	Páginas	Referência	Páginas
Referencia	Páginas	Referencia	Páginas
1158	81	6009	115
1159	81	6010	115
1160	81	6127	68
1300	86	6332	31
1715	58	6333	35
1717	59	6426	31
1720	59	6456	36
1721	60	6491	34
1722	57, 72, 74	6651	51
1735	63, 64	6652	51
1736	60	6653	52
1737	66	7006	52
1738	60	7542	21
1739	65	8260	45
1740	70	8261	45
1741	61	8262	45
1742	67	8263	45
1745	61	8264	45
1746	68	8265	45
1747	56, 62, 65, 69, 71, 75, 76	8326	96
1749	55, 56, 57, 58, 62, 64, 66, 69, 70, 71, 72, 73, 74, 75, 76, 77	8345	95
1750	63	8472	31
1751	67	8480TE	16
1752	77	8480TL	16
1921	34	8621	12
2030	25	8622	12
2031	25	8636	9
2032	26	8637	10
2072	99	8638	11
2074	99	8695	15
2080	100	8696	15
2084	99	8729	47
2085	100	8765	63, 64
2087	99	8835	13
2088	100	8836	13
2810	33	8837	13
3068	27	8838	14
3069	27	8839	14
3070	28	9044	109
3127	32	9049	106
3277	96	9090	107
3732	21	9091	107
3733	21	9092	107
4301	41	9093	107
4381	18	9094	107
4406	36	9095	107
4491	46	9322	32
4492	46	9327	32
4543	18	9406	31
4758	106	9705	102
4834	88	9715	103
4854	108	9716	103
4893	91	9717	104
4909	87	9724	101
4916	85	9739	105
4917	85	9746	105
4918	86	9763	106
4919	86	9813	110
4921	87	9814	111
4980	89	9821	111
4985	89	9846	111
4990	90	9875B1700	109
5321	33	120408	18
5322	35	120410	18
5355	37	120540	18
6007	115	120545	18
6008	115	150610	17

Referência	Páginas
Referencia	Páginas
150611	17
150612	17
150613	17
150614	17
150616	17
150617	17
150618	17
150619	17
150622	17
150624	17
150627	17
235100	16
235200	16
235206	16
340620	18
1215505	17
1215506	17
1215508	17
1215509	17
1215510	17
1215512	17
1215514	17
1215516	17
1261007	17
1261405	17
1262005	17
1262006	17
1262007	17
1262008	17
1262010	17
1262012	17
1262045	17
1262050	17
1262055	17
1262060	17
1262070	17
1265505	17
1265506	17
1265507	17
1265508	17
1265510	17
1265512	17
1265514	17
1265517	17
1265519	17
1265520	17
1265525	17
1265527	17
1265530	17
1265540	17
1265545	17
1265550	17
1265555	17
1265560	17
1265570	17
2352038	16
12120008	17
12120010	17
12120012	17
12120014	17
BAGC	119
GARRAFA2	119

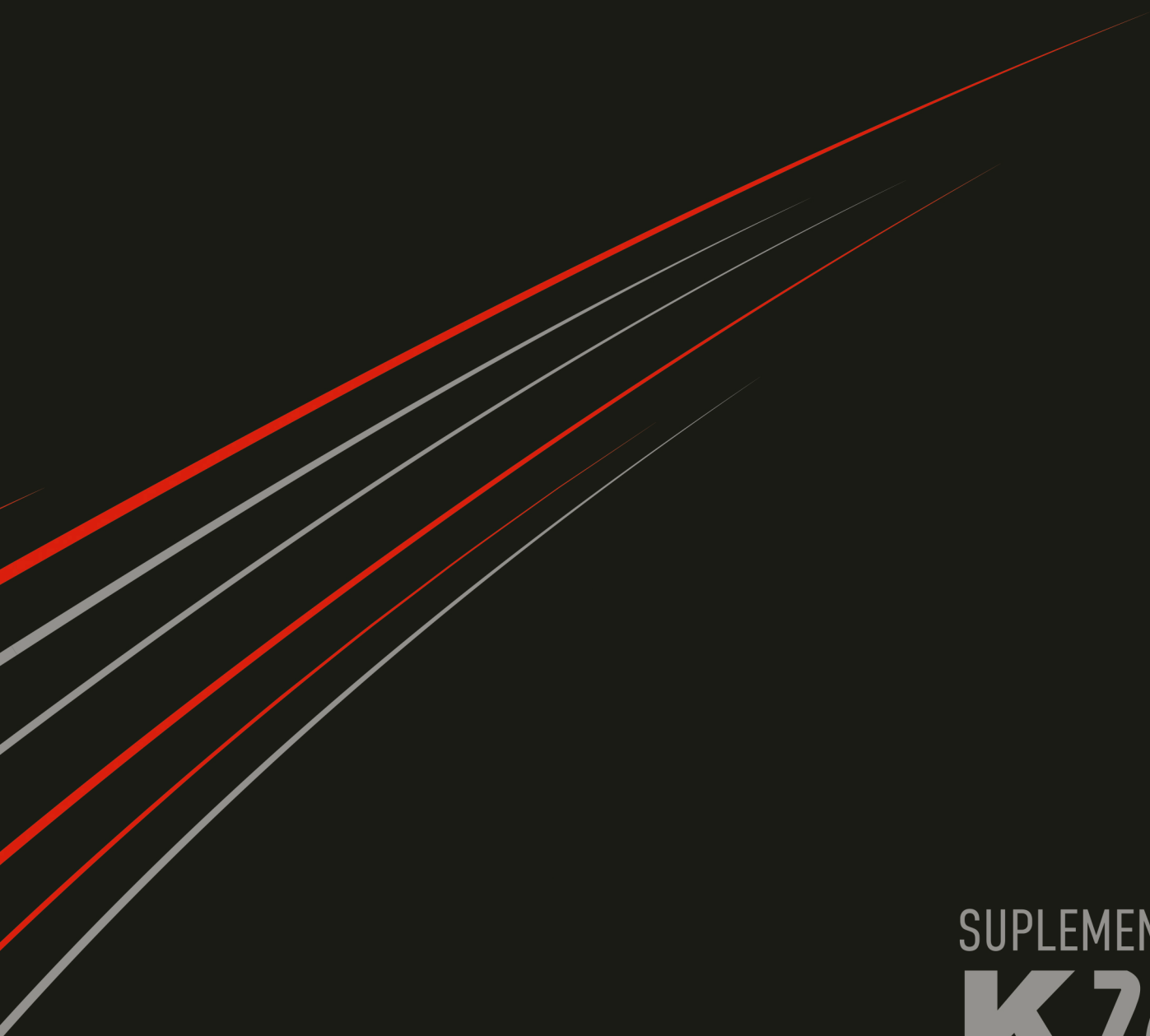

SUPLEMENTO  
**K26**

*WHEREVER WE GO, WE GO TOGETHER*



Distribuidor:

